

106 900... - 106 903...

HOFFMEISTER GmbH
 Gewerbering 28-30
 58579 Schalksmühle
 Germany

Phone: +49 (0) 23 55 - 50 41-0
 Fax: +49 (0) 23 55 - 50 41-328

www.hoffmeister.de
 mail@hoffmeister.de

Original **HOFFMEISTER**-Produkt - deshalb nur Original **HOFFMEISTER**-Teile verwenden.
 This is an original **HOFFMEISTER** product - therefore use original **HOFFMEISTER** parts only.
 Ceci est un produit d'origine **HOFFMEISTER** - pour cette raison, utiliser uniquement des pièces d'origine **HOFFMEISTER**.
 Eso es un producto original **HOFFMEISTER** - por eso utilizar solamente piezas originales **HOFFMEISTER**.
 Questo è un prodotto originale **HOFFMEISTER** - per questo impiegare esclusivamente pezzi originali **HOFFMEISTER**.

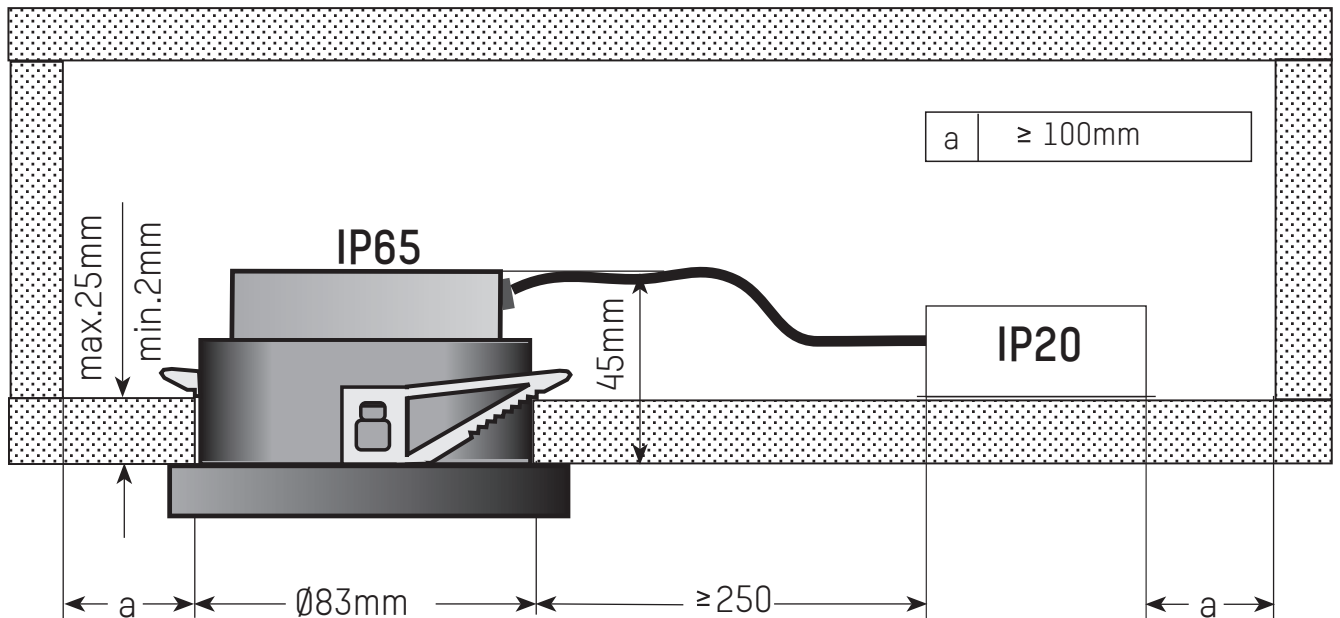

Unsere Gewährleistung gilt nur bei Beachtung dieser Produktinformation.

Sie erlischt insbesondere bei:

- Nichteinhaltung der Montagehinweise
- Veränderung der Leuchte
- Nichtbeachtung der Einbaumaße

Nuestra garantía depende de la observancia de este información sobre el producto.

Prescribe particularmente en los casos siguientes:

- no observación de las instrucciones de montaje
- modificación de la luminaria
- inobservancia de las dimensiones de empotrado

Our guarantee is contingent upon the observance of this product information.

In particular it does not apply in cases of:

- noncompliance with mounting instructions
- modification of the luminaire
- nonrespect of recessing dimensions

Nostra garanzia e dipendente della osservanza di questa informazione di prodotto.

Perde la validità particolarmente nel caso di:

- inosservanza dei istruzioni di montaggio
- modificazione dell'apparecchio di illuminazione
- inosservanza dei dimensioni di incasso

Notre garantie dépend de l'observation de cette information sur le produit.

Elle s'éteint notamment dans les cas suivants:

- non-observation des instructions de montage
- modification du luminaire
- non-respect des dimensions d'encastrement

106 829 02/2022

Dieses **Kontrollschein** bei Reklamationen bitte mit zurückschicken.

In case of complaints please return this **control label** with the product.

En cas de réclamation veuillez retourner cette **fiche de contrôle** avec le produit.

En caso de reclamaciones, sirvase devolvernos este **talón de inspección** junto con el producto.

Rispedire questa **bolletta di controlloinsieme** con il prodotto in caso di reclamo.

Produktions-Serie
 Production series
 Série de production
 Serie de producción
 Serie di produzione

106 900 03 721/906/910
 106 900 04 721/906/910
 106 902 03 721/906/910
 106 902 04 721/906/910

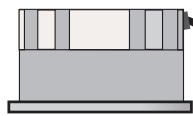

106 833-106838

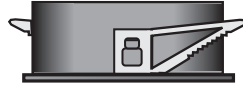

0.35700...

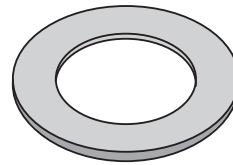

0.35711...

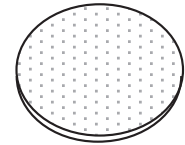

0.3572...

106 900 03 902
 106 900 04 902
 106 902 03 902
 106 902 04 902

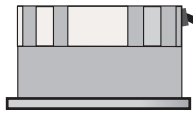

106 833-106838



0.35700...

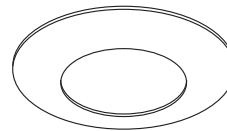

0.35707...

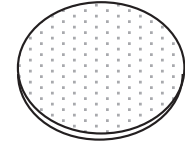

0.3572...

106 901 03 721/906/910
 106 901 04 721/906/910
 106 903 03 721/906/910
 106 903 04 721/906/910

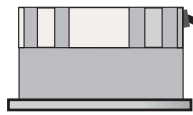

106 833-106838



0.35700...

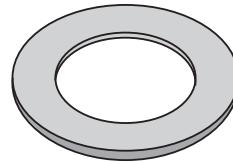

0.35711...

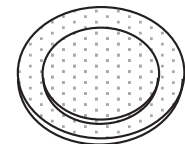

106 840

106 901 03 902
 106 901 04 902
 106 903 03 902
 106 903 04 902

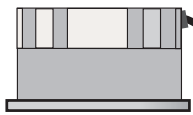

106 833-106838



0.35700...

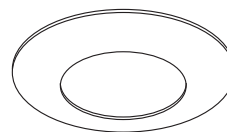

0.35707...

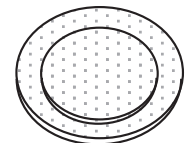

106 840

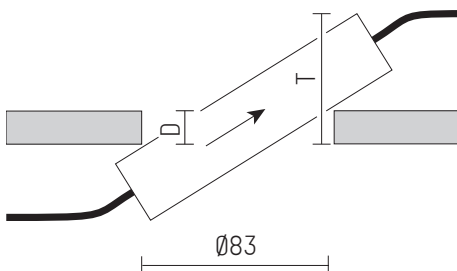
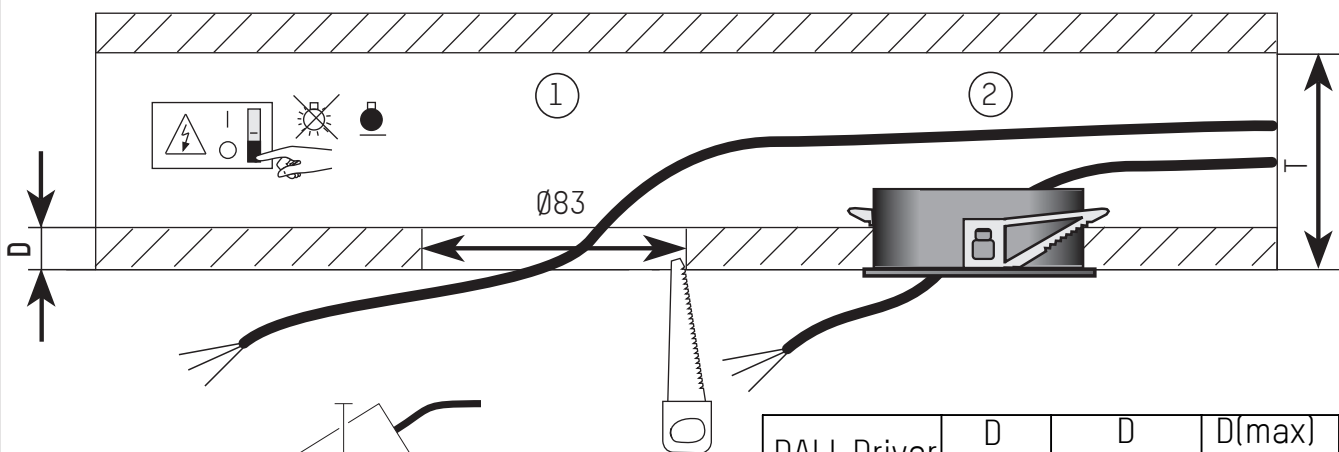

D [mm]	2	12,5	25
T [mm]	50	67	85

DALI-Driver	D	D	D(max)
	2mm	12,5mm	25mm
① T =	50	67	85
② T =	105	105	105
IP-Box	D	D	D(max)
	2mm	12,5mm	25mm
① T =	110	130	145
② T =	180	180	180

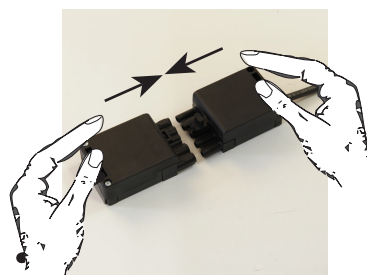
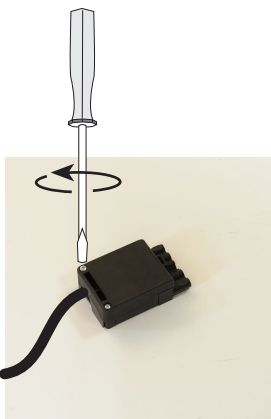
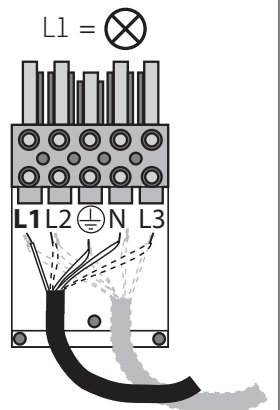
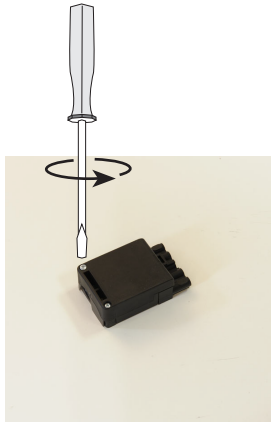
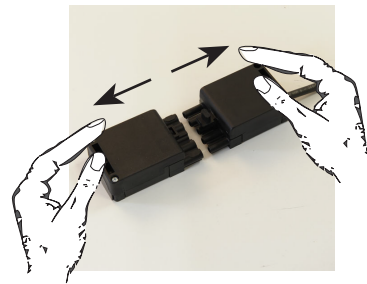
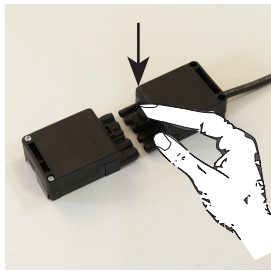
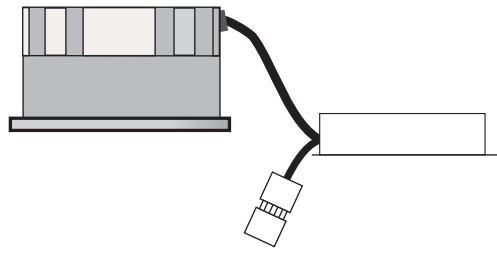
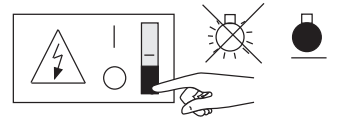
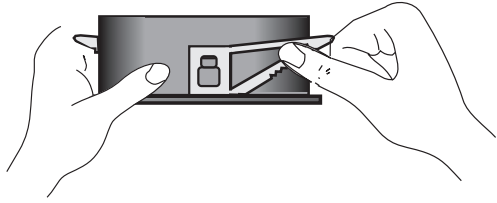
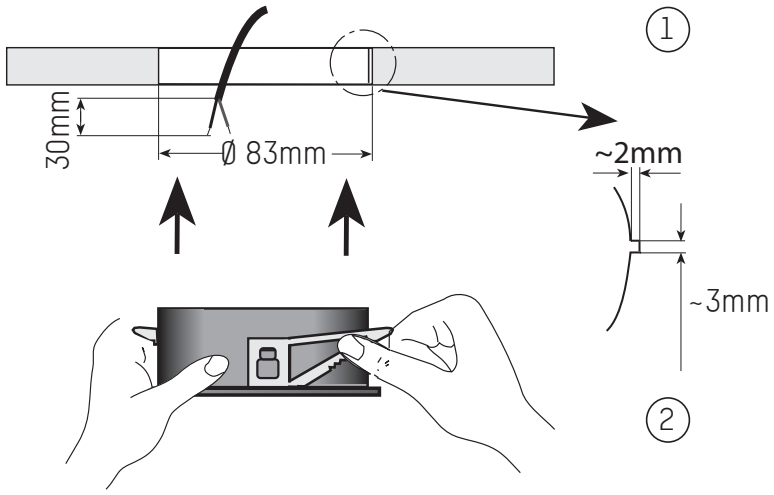

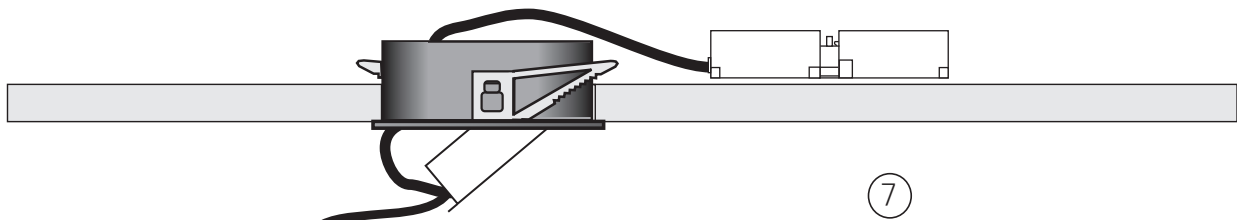

7

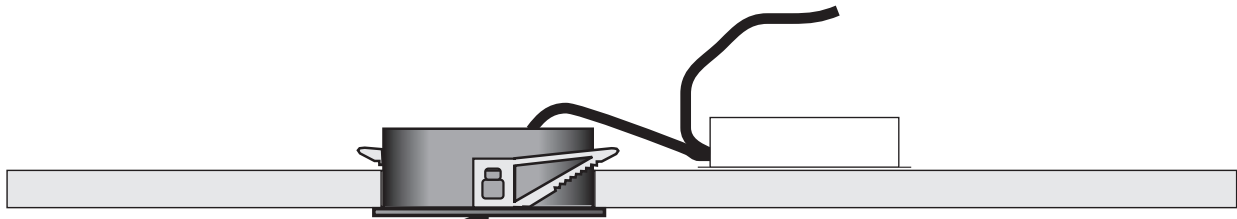
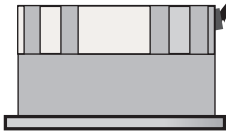

8



**Ersetze jede gebrochene Schutzscheibe!
Nicht ohne Schutzscheibe betreiben!**

Replace any broken cover glass!

Do not operate without cover glass!

Remplacer chaque verre protecteur cassé!

Ne pas utiliser sans verre protecteur!

Sustituir cada vidrio averiado!

No se utiliza sin vidrio de cubierta!

Sostituire ogni vetro di protezione danneggiato!

Non utilizzare senza vetro di protezione!

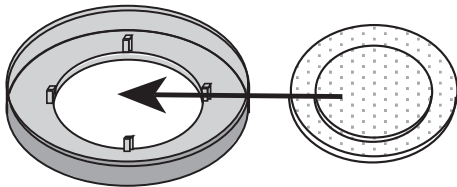

9

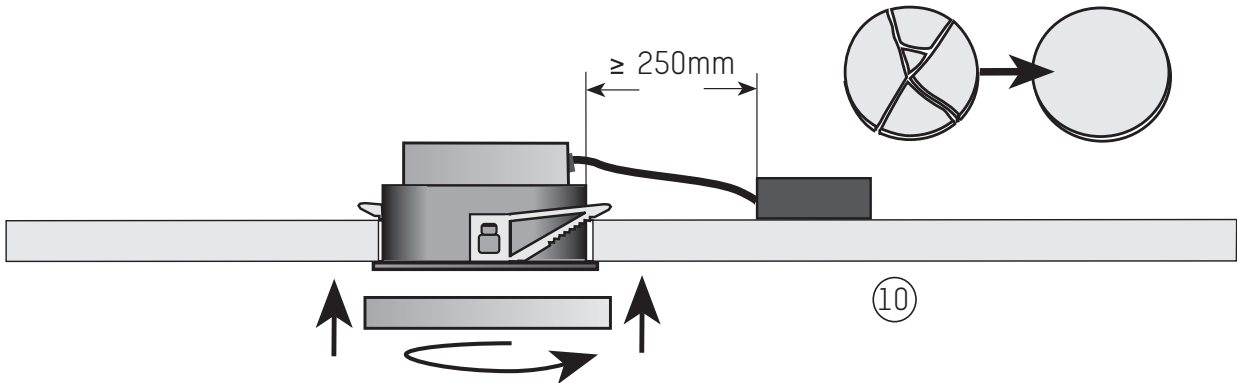

10

Service:

Bei Fragen wenden Sie sich bitte an unsere technische Hotline unter +49 2355 50 41 0
(Montag - Freitag von 08:00 Uhr bis 16:00 Uhr).

Service:

If you have any questions, please contact our technical hotline on +49 2355 50 41 0
(Monday - Friday from 8:00 a.m. to 4:00 p.m.).

Service:

En cas de questions, veuillez vous adresser au numéro de téléphone +49 2355 50 41 0 (du lundi au vendredi,
de 8 h. à 16 h.

Servicio técnico:

En caso de consultas, utilice nuestra línea de atención técnica preferente +49 2355 50 41 0
(lunes - viernes desde las 08:00 hasta 16:00 horas).

Servizio di assistenza:

Per maggiori informazioni rivolgetevi al nostro servizio tecnico di assistenza digitando il numero
+49 2355 50 41 0 (orari di apertura: da lunedì fino a venerdì dalle ore 08.00 fino alle ore 16.00).