

02S5030KWDE916 | silver

02S
projector
LED | 30 W 5700 K

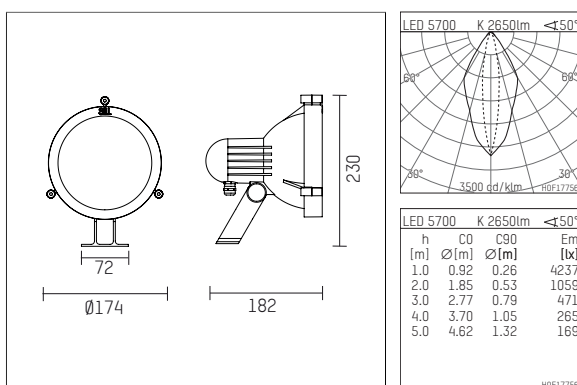

- projector 02S
- for wall-, ground and ceiling mounting
- with mounting bracket, pivots in two axes
- with LED 4400 lm
- colour temperature: 5700 K
- colour rendering index: CRI 80
- L90 / B10 (50.000h)
- SDCM < 3
- net luminous flux: 2650 lm
- total load: 30 W
- luminous efficacy: 88,3 lm/W
- oval flood horizontal
- $15^\circ \times 50^\circ$
- with built in LED power unit, electronic (DALI), 220-240 V, 0/50/60 Hz
- power supply: 4-pole supply cord 1,5 mm², Length: 500 mm
- With circular connector RST16 (Wieland) for cables with diameter 7,1-13mm and cross section 0,25-2,5mm.
- Connection outside of the luminaire housing for easier installation
- housing of die cast aluminium
- safety glass, clear
- length: 180 mm, width: 174 mm, height: 230 mm
- pivotable $-80^\circ/+40^\circ$
- windage area: 0,06 m²
- weight: 2,1 kg
- protection rating: IP65
- protection class II
- 5 years warranty
- designed and manufactured in Germany
- maximum ambient temperature: 40 ° C
- impact resistance class: IK08
- certificates: manufactured according to DIN VDE 0711 / EN 60598, CE
- colour: silver (RAL9006)
- 02S5030KWDE916

- Overview of accessories on the following page / s

02S5030KWDE916

accessory**Optional accessories**

description accessory general	dimensions in mm	item number	pic.-No.
Screen 45° length 165mm for projector 02S and 14S		814S04000916	01
tube screen length 71mm for projector 02S and 14S		814S05000916	02
supply cable, with system plug connector (female RST16i5) 4x1,5 2000mm		802M0021721	03
supply cable, with system plug connector (female RST16i5) 4x1,5 4000mm		802M0022721	03
supply cable, with system plug connector (female RST16i5) 4x1,5 6000mm		802M0023721	03
supply cable, with system plug connector (female RST16i5) 4x1,5 8000mm		802M0024721	03
supply cable, with system plug connector (female RST16i5) 4x1,5 10000mm		802M0025721	03
supply cable, with system plug connector (female RST16i5) 4x1,5 12000mm		802M0026721	03

