

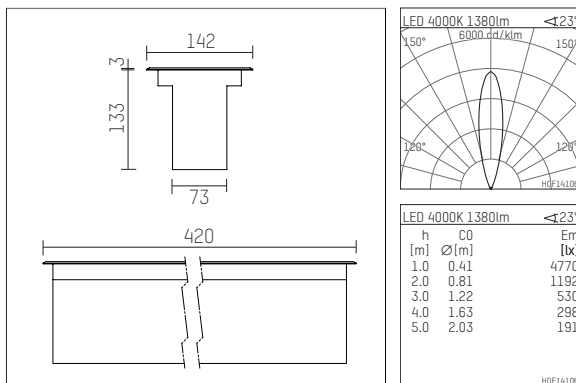

## 071 624 04 902 | stainless steel

hi.vertical 2.0  
inground luminaire  
LED | 15 W 4000 K



- inground luminaire hi.vertical 2.0
- for mounting into separate in-ground housing
- with LED 1750 lm
- colour temperature: 4000 K
- colour rendering index: CRI >80
- L80 / B10 (50.000h)
- SDCM < 2
- net luminous flux: 1380 lm
- total load: 15 W
- luminous efficacy: 92,0 lm/W
- symmetrical light distribution, medium
- beam angle: 25 °
- with built in LED power unit, electronic, 220-240 V, 0/50/60 Hz
- power supply: supply cord, H07RN-F 3x1,5 mm<sup>2</sup>, length: 700 mm
- housing of aluminium and die cast aluminium
- with stainless steel cover frame
- length: 420 mm, width: 142 mm
- recessing depth: 133 mm
- load capacity 1000 kg or 3000 kg with separate installation housing or housing for concrete
- adjustable optics ± 15°, adjustable from outside in operation
- weight: 6,2 kg
- protection rating: IP68 1m / 0,5h
- protection class I
- 5 years Hoffmeister warranty
- Made in Germany
- maximum ambient temperature: 50 ° C
- impact resistance class: IK10
- certificates: CE, manufactured according to DIN VDE 0711 / EN 60598
- colour: stainless steel
- 071 624 04 902

- Overview of accessories on the following page / s

071 624 04 902  
**accessory**

### Optional accessories

description accessory general	dimensions in mm	item number	pic.-No.
moulded sleeve for connecting to an underground cable	LxWxH: 150 x 75 x 50	071 213 00 000	01
connection sleeve IP68 for ground recessed luminaire	ØxL: 26,5 x 116	071 212 00 000	02
housing for concrete cast, made of stainless steel, up to 3t load capacity for ground recessed luminaire hi.vertical 2.0	LxWxH: 462 x 116 x 184	071 691 00 000	03
in-ground housing for ground recessed luminaire hi.vertical 2.0 - up to 3t load capacity	LxWxH: 466 x 174 x 173	071 696 00 000	04

