

**107 802 00 906 | silver**

form.h44 | 2000 mm  
base profile

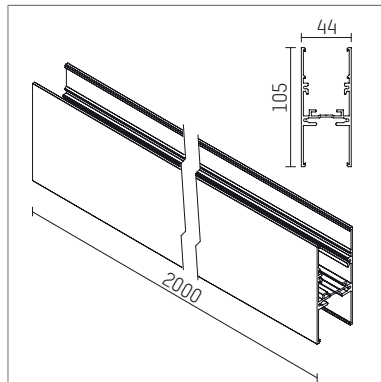

- base profile form.h44 2000 mm
- double-sided open profile to accommodate further components
- indirect: to accommodate T16/LED light inserts
- direct: to accommodate control.x tracks
- for suspended installation
- other combinations possible as special designs
- ready for suspension with steel cables or pendant rods
- feed-through wiring possible
- profiles and profile connectors connect smoothly thanks to secure mechanical toggle closure technology
- for each profile one connection kit is included
- housing of extruded aluminium profile
- length: 2000 mm, width: 44 mm, height: 105 mm
- weight: 3,32 kg
- 5 years Hoffmeister warranty
- Made in Germany
- certificates: manufactured according to DIN VDE 0711 / EN 60598, CE
- colour: silver
- 107 802 00 906

- Overview of accessories on the following page / s

107 802 00 906

**accessory**

## Optional accessories

description accessory general	dimensions in mm	item number	pic.-No.
cover transparent, L=872mm for form.h44	L: 872	107 821 00 000	01
cover transparent, L=1172mm for form.h44	L: 1172	107 822 00 000	01
cover transparent, L=1472mm for form.h44	L: 1472	107 823 00 000	01
cover transparent, L=1772mm for form.h44	L: 1772	107 824 00 000	01
supply cable, 3 x 0.75 mm <sup>2</sup> for form.h44	L: 2500	107 843 00 000	02
supply cable, 5 x 0.75 mm <sup>2</sup> for form.h44	L: 2500	107 845 00 000	02
supply cable, 7 x 0.75 mm <sup>2</sup> for form.h44	L: 2500	107 847 00 000	03
fixing element, control.x for form.h44	LxWxH: 23 x 15 x 2	107 836 00 000	04
mounting element fixing element for steel cable suspensions for form.h44	LxWxH: 22 x 40 x 9	107 840 00 000	05
mounting element, Type 90° fixing element for steel cable suspensions for form.h44	LxWxH: 55 x 55 x 9	107 841 00 000	06
mounting element, Type T/X fixing element for steel cable suspensions for form.h44	LxWxH: 72 x 39 x 9	107 842 00 000	07
mounting element for pendant tube suspensions for form.h44	LxWxH: 22 x 40 x 9	107 850 00 000	08
mounting element, Type 90° fixing element for pendant tube suspensions for form.h44	LxWxH: 55 x 55 x 9	107 851 00 000	06
mounting element, Type T/X fixing element for pendant tube suspensions for form.h44	LxWxH: 72 x 39 x 9	107 852 00 000	07
cover diffuse, L=1172mm for form.h44	L: 1172	107 822 00 927	09
cover diffuse, L=1472mm for form.h44	L: 1472	107 823 00 927	09
cover diffuse, L=1772mm for form.h44	L: 1772	107 824 00 927	09
cover diffuse, L=872mm for form.h44	L: 872	107 821 00 927	09
	L: 1172	107 816 03 000	10
	L: 1172	107 816 03 000 D	10
	L: 1172	107 816 04 000	10
	L: 1172	107 816 04 000 D	10
	L: 1472	107 817 03 000	10
	L: 1472	107 817 03 000 D	10
	L: 1472	107 817 04 000	10

107 802 00 906

**accessory**

## Optional accessories

description accessory general	dimensions in mm	item number	pic.-No.
	L: 1472	107 817 04 000 D	10
	L: 1772	107 818 03 000	10
	L: 1772	107 818 03 000 D	10
	L: 1772	107 818 04 000	10
	L: 1772	107 818 04 000 D	10
	L: 872	107 811 00 000	11
	L: 872	107 811 00 000 A	11
	L: 872	107 811 00 000 D	11
	L: 1172	107 812 00 000	11
	L: 1172	107 812 00 000 A	11
	L: 1172	107 812 00 000 D	11
	L: 1472	107 813 00 000	11
	L: 1472	107 813 00 000 A	11
cover, L=1000mm for form.h44	L: 1000	107 830 00 906	12
canopy, 2 x 7 x 2.5 mm <sup>2</sup> with connection possibility for form.h44	LxWxH: 84 x 84 x 82	107 848 00 906	13
canopy, 2 x 5 x 2.5 mm <sup>2</sup> with connection possibility for form.h44	LxWxH: 84 x 84 x 60	107 849 00 906	13
pendent tube, with cable, 3-pole for form.h44	LxWxH: 84 x 84 x 60	107 853 00 906	14
pendent tube, with cable, 5-pole for form.h44	LxWxH: 84 x 84 x 60	107 855 00 906	14
pendent tube, with cable, 7-pole for form.h44	LxWxH: 84 x 84 x 82	107 857 00 906	14
pendent tube for form.h44	LxWxH: 84 x 84 x 60	107 858 00 906	14
90° coupler for mechanical connection of form.h44 profiles	LxWxH: 103 x 103 x 105	107 831 00 906	15
T coupler for mechanical connection of form.h44 profiles	LxWxH: 161,5 x 103 x 105	107 832 00 906	16
end cap for form.h44 profiles	WxH: 44 x 105	107 835 00 906	17

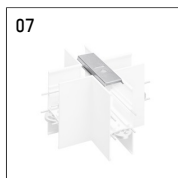
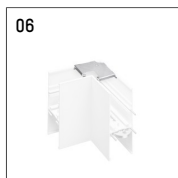
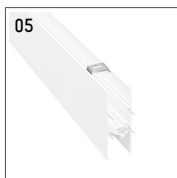
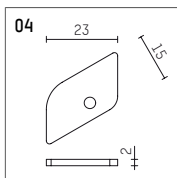
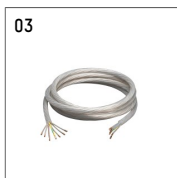
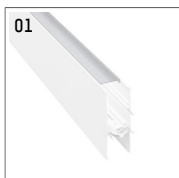

107 802 00 906  
accessory

