

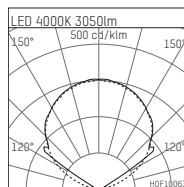

107 817 04 000

form.h44 | LED
light unit
LED | 23 W 4000 K

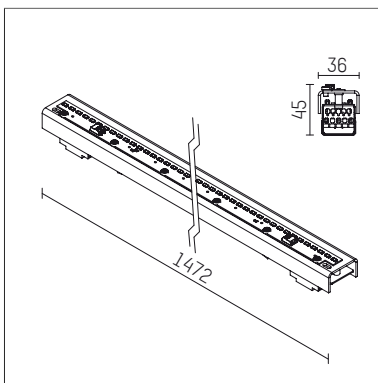

LED 4000K 3050lm		
$\eta_{LOR} = 100\%$		
E [lx]	100lx	500lx
a [m ²]	n=9	n=42
HOFFMEISTER		

- light unit form.h44 LED
- for form h.44 profiles
- suitable for forming continuous strip lighting systems
- with LED 3550 lm
- colour temperature: 4000 K
- colour rendering index: CRI >90
- L70 / B50 (50.000h)
- SDCM < 3
- net luminous flux: 3050 lm
- total load: 23 W
- luminous efficacy: 132,6 lm/W
- symmetrical light distribution, wide flood
- with built in LED power unit, electronic
- power supply: push-wire terminal 2x5x1,5 mm²
- suitable for through wiring
- mounting of sheet steel
- length: 1472 mm
- weight: 1,4 kg
- protection rating: IP20
- protection class I
- 5 years Hoffmeister warranty
- Made in Germany
- certificates: manufactured according to DIN VDE 0711 / EN 60598, CE
- 107 817 04 000

- - -