

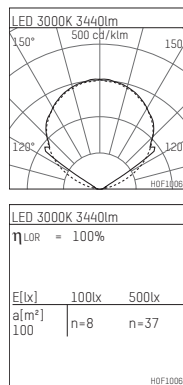

107 818 03 000

form.h44 | LED
light unit
LED | 26 W 3000 K

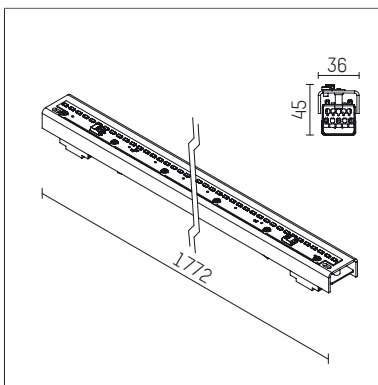

- light unit form.h44 LED
- for form h.44 profiles
- suitable for forming continuous strip lighting systems
- with LED 4000 lm
- colour temperature: 3000 K
- colour rendering index: CRI >90
- L70 / B50 (50.000h)
- SDCM < 3
- net luminous flux: 3440 lm
- total load: 26 W
- luminous efficacy: 132,3 lm/W
- symmetrical light distribution, wide flood
- with built in LED power unit, electronic
- power supply: push-wire terminal 2x5x1,5 mm²
- suitable for through wiring
- mounting of sheet steel
- length: 1772 mm
- weight: 1,6 kg
- protection rating: IP20
- protection class I
- 5 years Hoffmeister warranty
- Made in Germany
- certificates: manufactured according to DIN VDE 0711 / EN 60598, CE
- 107 818 03 000

- - -