

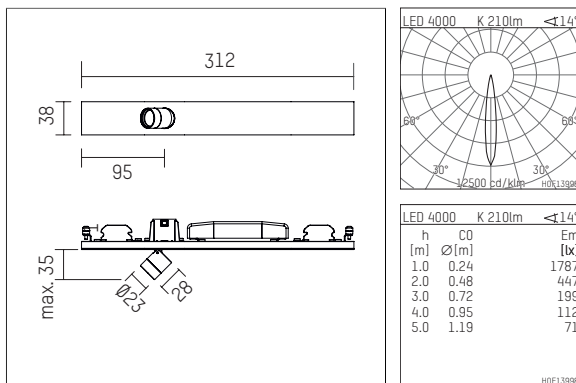

107 862 04 721 | black anodised

ak.tina | with one point of light
spotlight module
LED | 5 W 4000 K



- spotlight module ak.tina with one point of light
- for form h.44 profiles
- with LED 260 lm
- colour temperature: 4000 K
- colour rendering index: CRI >80
- L90 / B10 (50.000h)
- SDCM < 2
- net luminous flux: 210 lm
- total load: 5 W
- luminous efficacy: 42,0 lm/W
- rotationsymmetrical light distribution, spot
- build in LED power unit, electronic, 220-240 V, 0/50/60 Hz
- housing of aluminium
- length: 312 mm, width: 38 mm, height: 35 mm
- rotatable 360°, 90° tiltable
- weight: 0,28 kg
- protection rating: IP20
- protection class I
- 5 years Hoffmeister warranty
- Made in Germany
- maximum ambient temperature: 35 °C
- certificates: manufactured according to DIN VDE 0711 / EN 60598, CE
- colour: black anodised
- 107 862 04 721

- Overview of accessories on the following page / s

107 862 04 721
accessory

Optional accessories

description accessory general	dimensions in mm	item number	pic.-No.
antiglare flaps for ak.tina		120 992 00 721	01
tube screen for ak.tina		120 990 00 721	02
visor for ak.tina		120 991 00 721	03
connection ring, with prismatic glass for ak.tina		120 996 00 721	04
connection ring, with soft.shape lense for ak.tina		120 994 00 721	04
connection ring, with sculpture lens for ak.tina		120 995 00 721	04
connection ring, with honeycomb louver for ak.tina		120 993 00 721	05
connection ring, with wide-flood lense for ak.tina		120 997 00 721	04

