

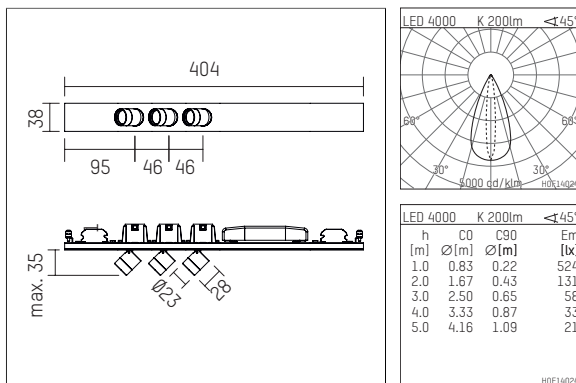

107 886 04 907 | silver anodised

ak.tina | with three points of light
spotlight module
LED | 3 W 4000 K



- spotlight module ak.tina with three points of light
- for form h.44 profiles
- Performance data per point of light
- with LED 780 lm
- colour temperature: 4000 K
- colour rendering index: CRI >80
- L90 / B10 (50.000h)
- SDCM < 2
- net luminous flux: 200 lm
- total load: 3 W
- luminous efficacy: 66,7 lm/W
- bisymmetrical light distribution, oval flood horizontal
- with built in LED power unit, electronic, 220-240 V, 0/50/60 Hz
- housing of aluminium
- length: 404 mm, width: 38 mm, height: 35 mm
- rotatable 360°, 90° tiltable
- weight: 0 kg
- protection rating: IP20
- protection class I
- 5 years Hoffmeister warranty
- Made in Germany
- maximum ambient temperature: 35 °C
- certificates: manufactured according to DIN VDE 0711 / EN 60598, CE
- colour: silver anodised
- 107 886 04 907

- Overview of accessories on the following page / s

107 886 04 907
accessory

Optional accessories

description accessory general	dimensions in mm	item number	pic.-No.
antiglare flaps for ak.tina		120 992 00 721	01
tube screen for ak.tina		120 990 00 907	02
visor for ak.tina		120 991 00 907	03
connection ring, with prismatic glass for ak.tina		120 996 00 907	04
connection ring, with soft.shape lense for ak.tina		120 994 00 907	04
connection ring, with sculpture lens for ak.tina		120 995 00 907	04
connection ring, with honeycomb louver for ak.tina		120 993 00 907	04
connection ring, with wide-flood lense for ak.tina		120 997 00 907	04

