

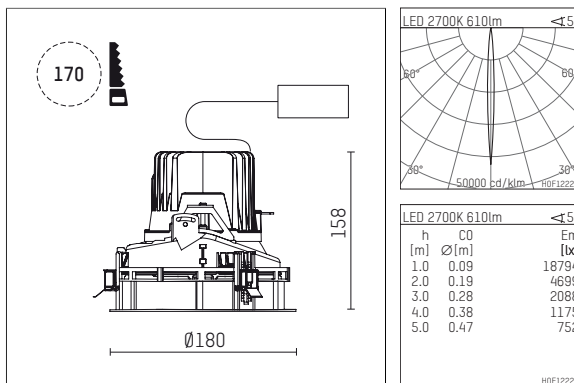

108 100 02 910 RD | white

complx.150 | rim
ceiling recessed luminaire
LED | 15 W 2700 K



- ceiling recessed luminaire complx.150 rim
- with a rim projecting over the ceiling
- for installation into suspended ceilings
- with LED 840 lm
- colour temperature: 2700 K
- colour rendering index: CRI >90
- L90 / B10 (50.000h)
- SDCM < 3
- net luminous flux: 610 lm
- total load: 15 W
- luminous efficacy: 40,7 lm/W
- rotationsymmetrical light distribution, narrow spot
- safety cable for reflector module
- darklight reflector of aluminium, mirror finish anodised
- cut of angle: 30 °
- beam angle: 5 °
- UGR: -1
- with external LED power unit, electronic (DALI), 220-240 V, 0/50/60 Hz
- amplitude dimming
- dimming range: 100-1 %
- power supply: supply cord with plug connection 2x5x2,5 mm², length: 360 mm
- housing of die cast aluminium
- safety glass, clear
- recessing ring of die cast aluminium
- height: 153 mm
- diameter: 180 mm, recessing diameter: 170 mm
- recessing depth: 158 mm, ceiling thickness: 1-35 mm
- rotatable 360°, fixable setting
- weight: 1,3 kg
- protection rating: IP20
- protection class I
- 5 years Hoffmeister warranty
- Made in Germany
- certificates: manufactured according to DIN VDE 0711 / EN 60598, CE
- colour: white (RAL9016)
- 108 100 02 910 RD

- Overview of accessories on the following page / s

108 100 02 910 RD
accessory**Optional accessories**

description accessory general	dimensions in mm	item number	pic.-No.
housing for concrete cast for recessed downlights complx.150 rim	ØxH: 422 x 160	108 005 10 000	01

01