

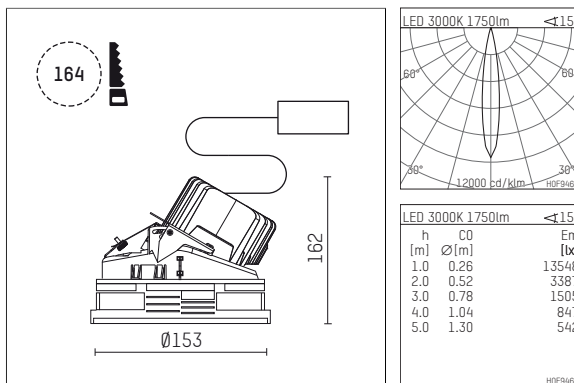

108 121 03 910 SD | white

complx.150 | insider
directional spotlight
LED | 28 W 3000 K



- directional spotlight complx.150 insider
- with ceiling-flush recessing ring
- for plastering into plasterboard ceilings
- with LED 2400 lm
- colour temperature: 3000 K
- colour rendering index: CRI >90
- L90 / B10 (50.000h)
- SDCM < 2
- net luminous flux: 1750 lm
- total load: 28 W
- luminous efficacy: 62,5 lm/W
- rotationsymmetrical light distribution, spot
- aluminium darklight reflector, mirror finish anodized
- safety-rope for reflector modules
- beam angle: 15 °
- with external LED power unit, electronic (DALI), 220-240 V, 0/50/60 Hz
- amplitude dimming
- dimming range: 100-1 %
- power supply: supply cord with plug connection 2x5x2,5 mm², length: 360 mm
- suitable for through wiring
- housing of die cast aluminium
- safety glass, clear
- recessing ring of die cast aluminium
- height: 149 mm
- diameter: 153 mm, recessing diameter: 164 mm
- recessing depth: 162 mm, ceiling thickness: for 12.5/15/18/20/25 mm
- rotatable 360°, fixable setting, 0°-30° tiltable, fixable setting
- weight: 1,28 kg
- protection rating: IP20
- protection class I
- 5 years Hoffmeister warranty
- Made in Germany
- certificates: manufactured according to DIN VDE 0711 / EN 60598, CE
- colour: white (RAL9016)
- 108 121 03 910 SD

- Overview of accessories on the following page / s

108 121 03 910 SD
accessory**Optional accessories**

description accessory general	dimensions in mm	item number	pic.-No.
housing for concrete cast for recessed downlights complx.150 INSIDER	ØxH: 422 x 160	108 008 10 000	01
housing for concrete cast for recessed downlights complx.150 INSIDER	ØxH: 422 x 170	108 007 10 000	01

01