

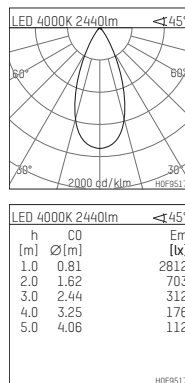

108 123 04 910 PD | white

complx.150 | insider
directional spotlight
LED | 28 W 4000 K

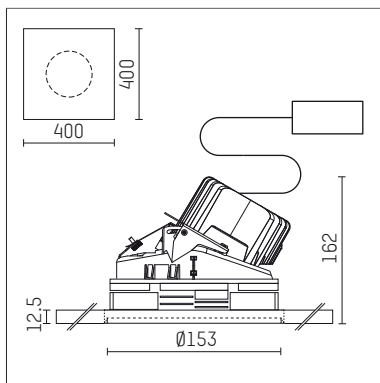

- directional spotlight complx.150 insider
- with plasterboard panel and integrated installation frame
- with LED 3150 lm
- colour temperature: 4000 K
- colour rendering index: CRI >80
- L90 / B10 (50.000h)
- SDCM < 2
- net luminous flux: 2440 lm
- total load: 28 W
- luminous efficacy: 87,1 lm/W
- rotationsymmetrical light distribution, flood
- aluminium darklight reflector, mirror finish anodized
- safety-rope for reflector modules
- beam angle: 45 °
- with external LED power unit, electronic (DALI), 220-240 V, 0/50/60 Hz
- amplitude dimming
- dimming range: 100-1 %
- power supply: supply cord with plug connection 2x5x2,5 mm², length: 360 mm
- suitable for through wiring
- housing of die cast aluminium
- microprismatic filter with very high rate of light transmission
- recessing ring of die cast aluminium
- length: 400 mm, width: 400 mm, height: 149 mm
- diameter: 153 mm
- recessing depth: 162 mm, ceiling thickness: 12.5 mm
- rotatable 360°, fixable setting, 0°-30° tiltable, fixable setting
- weight: 3,2 kg
- protection rating: IP20
- protection class I
- 5 years Hoffmeister warranty
- Made in Germany
- certificates: manufactured according to DIN VDE 0711 / EN 60598, CE
- colour: white (RAL9016)
- 108 123 04 910 PD

- - -