

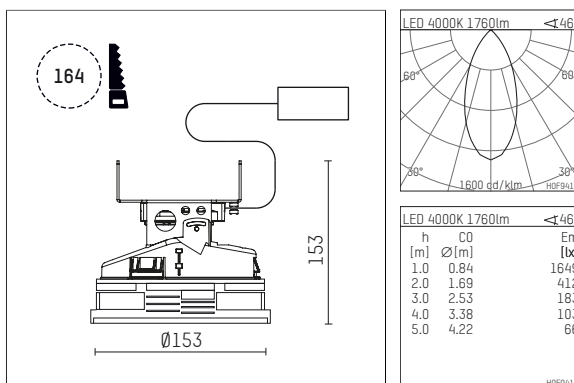

108 134 04 910 S | white

complx.150 | insider
ceiling recessed luminaire
LED Fortimo Flex | 19 W 4000 K



- ceiling recessed luminaire complx.150 insider
- with ceiling-flush recessing ring
- for plastering into plasterboard ceilings
- with LED Fortimo Flex 2000 lm
- colour temperature: 4000 K
- colour rendering index: CRI 80
- L70 / B20 (50.000h)
- SDCM < 3
- net luminous flux: 1760 lm
- total load: 19 W
- luminous efficacy: 92,6 lm/W
- rotationsymmetrical light distribution, flood
- safety cable for reflector module
- darklight reflector of aluminium, mirror finish anodised
- cut of angle: 40°
- UGR: 15
- with external LED power unit, electronic, 220-240 V, 0/50/60 Hz
- power supply: push-wire terminal 2x5x2,5 mm²
- recessing ring of die cast aluminium
- aluminium cooling elements
- height: 150 mm
- diameter: 153 mm, recessing diameter: 164 mm
- recessing depth: 153 mm, ceiling thickness: for 12.5/15/18/20/25 mm
- rotatable 360° , fixable setting
- weight: 1,45 kg
- protection rating: IP20
- protection class II
- 5 years Hoffmeister warranty
- Made in Germany
- certificates: manufactured according to DIN VDE 0711 / EN 60598, CE
- colour: white (RAL9016)
- 108 134 04 910 S

- Overview of accessories on the following page / s

108 134 04 910 S
accessory**Optional accessories**

description accessory general	dimensions in mm	item number	pic.-No.
housing for concrete cast for recessed downlights complx.150 INSIDER	ØxH: 422 x 160	108 008 10 000	01
housing for concrete cast for recessed downlights complx.150 INSIDER	ØxH: 422 x 170	108 007 10 000	01

**01**