

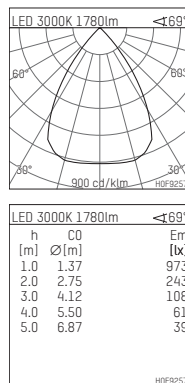

## 108 135 03 910 SD | white

complx.150 | insider  
ceiling recessed luminaire  
LED Fortimo Flex | 21 W 3000 K

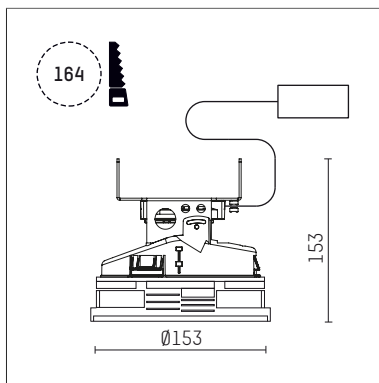

- ceiling recessed luminaire complx.150 insider
- with ceiling-flush recessing ring
- for plastering into plasterboard ceilings
- with LED Fortimo Flex 2000 lm
- colour temperature: 3000 K
- colour rendering index: CRI 80
- L70 / B20 (50.000h)
- SDCM < 3
- net luminous flux: 1780 lm
- total load: 21 W
- luminous efficacy: 84,8 lm/W
- rotationsymmetrical light distribution, wide flood
- safety cable for reflector module
- darklight reflector of aluminium, mirror finish anodised
- cut of angle: 40 °
- UGR: 17
- with external LED power unit, electronic (DALI), 220-240 V, 0/50/60 Hz
- amplitude dimming
- dimming range: 100-1 %
- power supply: push-wire terminal 2x5x2,5 mm<sup>2</sup>
- recessing ring of die cast aluminium
- aluminium cooling elements
- height: 150 mm
- diameter: 153 mm, recessing diameter: 164 mm
- recessing depth: 153 mm, ceiling thickness: for 12.5/15/18/20/25 mm
- rotatable 360°, fixable setting
- weight: 1,45 kg
- protection rating: IP20
- protection class II
- 5 years Hoffmeister warranty
- Made in Germany
- certificates: manufactured according to DIN VDE 0711 / EN 60598, CE
- colour: white (RAL9016)
- 108 135 03 910 SD

- Overview of accessories on the following page / s

108 135 03 910 SD  
**accessory****Optional accessories**

description accessory general	dimensions in mm	item number	pic.-No.
housing for concrete cast for recessed downlights complx.150 INSIDER	ØxH: 422 x 160	108 008 10 000	01
housing for concrete cast for recessed downlights complx.150 INSIDER	ØxH: 422 x 170	108 007 10 000	01

01