

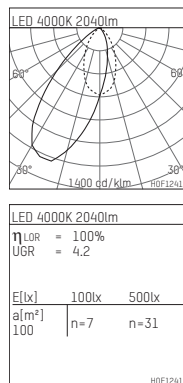

108 311 04 910 SD | white

complx.200 | insider
lens wall floodlight
LED | 37 W 4000 K

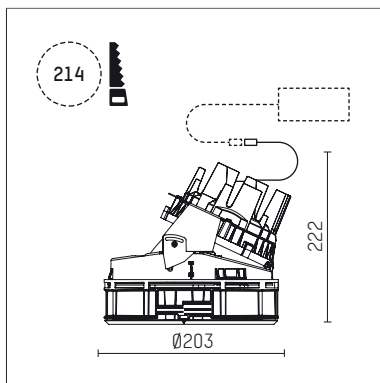

- lens wall floodlight complx.200 insider
- with integrated lens system for homogenous wall illumination
- with ceiling-flush recessing ring
- for installation into suspended ceilings
- with LED 3400 lm
- colour temperature: 4000 K
- colour rendering index: CRI >80
- L90 / B10 (50.000h)
- SDCM < 3
- net luminous flux: 2040 lm
- total load: 37 W
- luminous efficacy: 55,1 lm/W
- asymmetrical light distribution
- safety cable for reflector module
- soft-lens optic with secondary reflector
- darklight reflector of aluminium, mirror finish anodised
- UGR: 4
- with external LED power unit, electronic (DALI), 220-240 V, 0/50/60 Hz
- temperature-controlled LED circuit board (NTC)
- dimmable
- dimming range: 100-1 %
- power supply: supply cord with plug connection 2x5x2,5 mm², length: 360 mm
- housing of die cast aluminium
- safety glass
- recessing ring of die cast aluminium
- height: 202 mm
- diameter: 203 mm, recessing diameter: 214 mm
- recessing depth: 222 mm, ceiling thickness: for 12.5/15/18/20/25 mm
- rotatable 360°, fixable setting
- weight: 2,424 kg
- protection rating: IP20
- protection class I
- 5 years Hoffmeister warranty
- Made in Germany
- certificates: manufactured according to DIN VDE 0711 / EN 60598, CE
- colour: white (RAL9016)
- 108 311 04 910 SD

- - -