

## 108 316 04 910 S | white

complx.200 | insider  
ceiling recessed luminaire  
LED | 37 W 4000 K

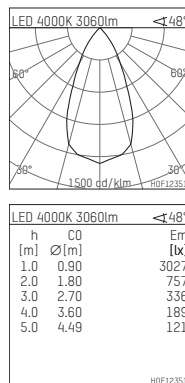
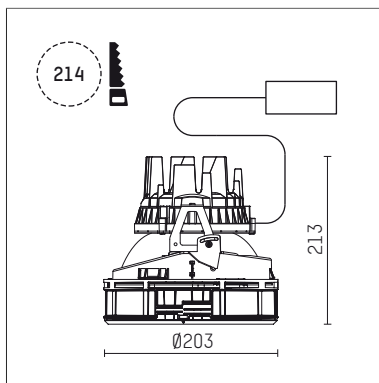

- ceiling recessed luminaire complx.200 insider
- with ceiling-flush recessing ring
- for plastering into plasterboard ceilings
- with LED 4400 lm
- colour temperature: 4000 K
- colour rendering index: CRI >80
- L90 / B10 (50.000h)
- SDCM < 2
- net luminous flux: 3060 lm
- total load: 37 W
- luminous efficacy: 82,7 lm/W
- rotationsymmetrical light distribution, flood
- safety cable for reflector module
- darklight reflector of aluminium, mirror finish anodised
- cut of angle: 40 °
- UGR: 14
- with external LED power unit, electronic, 220-240 V, 0/50/60 Hz
- temperature-controlled LED circuit board (NTC)
- power supply: push-wire terminal 2,5 mm<sup>2</sup>
- housing of die cast aluminium
- recessing ring of die cast aluminium
- height: 208 mm
- diameter: 203 mm, recessing diameter: 214 mm
- recessing depth: 213 mm, ceiling thickness: for 12.5/15/18/20/25 mm
- rotatable 360°, fixable setting
- weight: 2,13 kg
- protection rating: IP20
- protection class I
- 5 years Hoffmeister warranty
- Made in Germany
- certificates: manufactured according to DIN VDE 0711 / EN 60598, CE
- colour: white (RAL9016)
- 108 316 04 910 S

- - -