

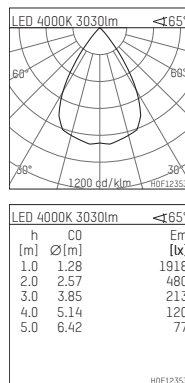

108 317 04 910 RD | white

complx.200 | rim
ceiling recessed luminaire
LED | 37 W 4000 K

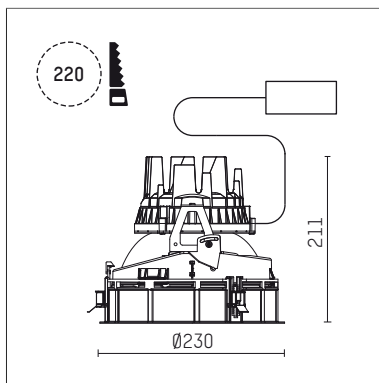

- ceiling recessed luminaire complx.200 rim
- with a rim projecting over the ceiling
- for installation into suspended ceilings
- with LED 4400 lm
- colour temperature: 4000 K
- colour rendering index: CRI >80
- L90 / B10 (50.000h)
- SDCM < 2
- net luminous flux: 3030 lm
- total load: 37 W
- luminous efficacy: 81,9 lm/W
- rotationsymmetrical light distribution, wide flood
- safety cable for reflector module
- darklight reflector of aluminium, mirror finish anodised
- cut of angle: 40 °
- UGR: 16
- with external LED power unit, electronic (DALI), 220-240 V, 0/50/60 Hz
- temperature-controlled LED circuit board (NTC)
- dimmable
- dimming range: 100-1 %
- power supply: push-wire terminal 2x7x2,5 mm²
- housing of die cast aluminium
- recessing ring of die cast aluminium
- height: 206 mm
- diameter: 230 mm, recessing diameter: 220 mm
- recessing depth: 211 mm, ceiling thickness: 1-35 mm
- rotatable 360°, fixable setting
- weight: 2,16 kg
- protection rating: IP20
- protection class I
- 5 years Hoffmeister warranty
- Made in Germany
- certificates: manufactured according to DIN VDE 0711 / EN 60598, CE
- colour: white (RAL9016)
- 108 317 04 910 RD
