

## 108 324 03 910 P | white

complx.200 | insider  
directional spotlight  
LED | 26 W 3000 K

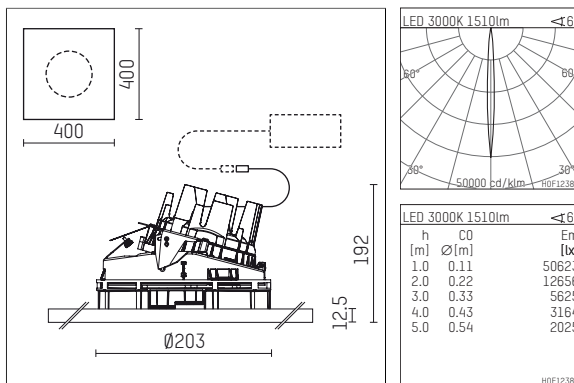

- directional spotlight complx.200 insider
- with plasterboard panel and integrated installation frame
- with LED 1900 lm
- colour temperature: 3000 K
- colour rendering index: CRI >90
- L90 / B10 (50.000h)
- SDCM < 2
- net luminous flux: 1510 lm
- total load: 26 W
- luminous efficacy: 58,1 lm/W
- rotationsymmetrical light distribution, narrow spot
- aluminium darklight reflector, mirror finish anodized
- safety-rope for reflector modules
- beam angle: 5 °
- with external LED power unit, electronic, 220-240 V, 0/50/60 Hz
- temperature-controlled LED circuit board (NTC)
- power supply: supply cord with plug connection 2x5x2,5 mm², length: 360 mm
- suitable for through wiring
- housing of die cast aluminium
- safety glass, clear
- recessing ring of die cast aluminium
- length: 400 mm, width: 400 mm, height: 177 mm
- diameter: 203 mm
- recessing depth: 192 mm, ceiling thickness: 12.5 mm
- rotatable 360°, fixable setting, 0°-30° tiltable, fixable setting
- weight: 0 kg
- protection rating: IP20
- protection class I
- 5 years Hoffmeister warranty
- Made in Germany
- certificates: manufactured according to DIN VDE 0711 / EN 60598, CE
- colour: white (RAL9016)
- 108 324 03 910 P

- - -