

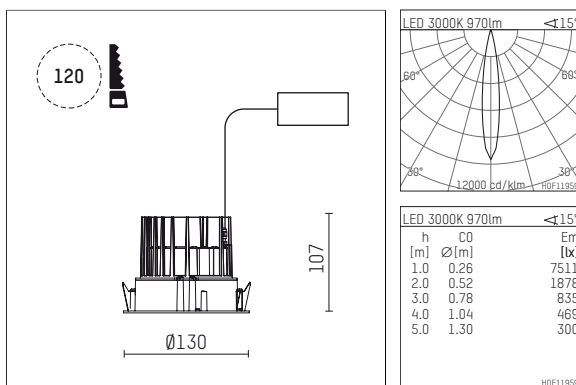

108 702 03 910 R | white

complx.100 | rim
ceiling recessed luminaire
LED | 14 W 3000 K



- ceiling recessed luminaire complx.100 rim
- with a rim projecting over the ceiling
- for installation into suspended ceilings
- with LED 1200 lm
- colour temperature: 3000 K
- colour rendering index: CRI >90
- L90 / B10 (50.000h)
- SDCM < 2
- net luminous flux: 970 lm
- total load: 14 W
- luminous efficacy: 69,3 lm/W
- rotationsymmetrical light distribution, spot, mirror finish anodised
- cut of angle: 30 °
- beam angle: 15 °
- UGR: 4
- with external LED power unit, electronic, 220-240 V, 50/60 Hz
- Dimming with external dimmers possible (trailing-edge and leading-edge)
- dimmable
- power supply: supply cord with plug connection 2x5x2,5 mm², length: 360 mm
- housing of die cast aluminium
- safety glass, clear
- recessing ring of die cast aluminium
- height: 97 mm
- diameter: 130 mm, recessing diameter: 120 mm
- recessing depth: 107 mm, ceiling thickness: 2-25mm
- weight: 0,65 kg
- protection rating: IP20
- protection class I
- 5 years Hoffmeister warranty
- Made in Germany
- certificates: manufactured according to DIN VDE 0711 / EN 60598, CE
- colour: white (RAL9016)
- 108 702 03 910 R

- Overview of accessories on the following page / s

108 702 03 910 R
accessory**Optional accessories**

description accessory general	dimensions in mm	item number	pic.-No.
housing for concrete cast for recessed downlights complx.100 rim	ØxH: 342 x 160	108 605 10 000	01

01