

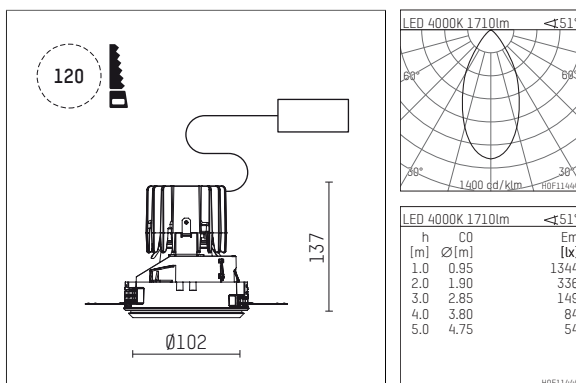

108 706 04 910 S | white

complx.100 | insider
ceiling recessed luminaire
LED | 21 W 4000 K



- ceiling recessed luminaire complx.100 insider
- with ceiling-flush recessing ring
- for plastering into plasterboard ceilings
- with LED 2350 lm
- colour temperature: 4000 K
- colour rendering index: CRI >80
- L90 / B10 (50.000h)
- SDCM < 2
- net luminous flux: 1710 lm
- total load: 21 W
- luminous efficacy: 81,4 lm/W
- rotationsymmetrical light distribution, flood
- darklight reflector of aluminium, mirror finish anodised
- cut of angle: 30 °
- UGR: 19
- with external LED power unit, electronic, 220-240 V, 50/60 Hz
- Dimming with external dimmers possible (trailing-edge and leading-edge)
- dimmable
- power supply: supply cord with plug connection 2x5x2,5 mm², length: 360 mm
- housing of die cast aluminium
- recessing ring of die cast aluminium
- height: 127 mm
- diameter: 102 mm, recessing diameter: 120 mm
- recessing depth: 137 mm, ceiling thickness: for 12.5/15/18/20/25 mm
- weight: 0,7 kg
- protection rating: IP20
- protection class I
- 5 years Hoffmeister warranty
- Made in Germany
- certificates: manufactured according to DIN VDE 0711 / EN 60598, CE
- colour: white (RAL9016)
- 108 706 04 910 S

- Overview of accessories on the following page / s

108 706 04 910 S
accessory**Optional accessories**

description accessory general	dimensions in mm	item number	pic.-No.
housing for concrete cast for recessed downlights complx.100 INSIDER	ØxH: 342 x 160	108 608 10 000	01
housing for concrete cast for recessed downlights complx.100 INSIDER	ØxH: 342 x 170	108 607 10 000	01

01