

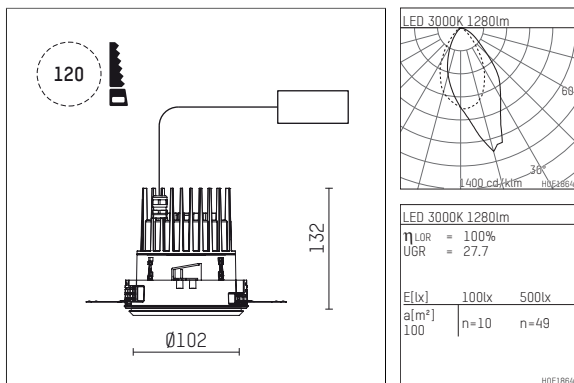

## 108 711 03 910 S | white

complx.100 | insider  
lens wall floodlight  
LED | 21 W 3000 K



- lens wall floodlight complx.100 insider
- with integrated lens system for homogenous wall illumination
- with ceiling-flush recessing ring
- for plastering into plasterboard ceilings
- with LED 1800 lm
- colour temperature: 3000 K
- colour rendering index: CRI >90
- L90 / B10 (50.000h)
- SDCM < 2
- net luminous flux: 1280 lm
- total load: 21 W
- luminous efficacy: 61,0 lm/W
- asymmetrical light distribution
- safety cable for reflector module
- darklight reflector of aluminium, mirror finish anodised
- cut of angle: 40 °
- UGR: 28
- with external LED power unit, electronic, 220-240 V, 50/60 Hz
- Dimming with external dimmers possible (trailing-edge and leading-edge)
- dimmable
- power supply: supply cord with plug connection 2x5x2,5 mm<sup>2</sup>, length: 360 mm
- housing of die cast aluminium
- recessing ring of die cast aluminium
- height: 122 mm
- diameter: 102 mm
- recessing depth: 132 mm, ceiling thickness: 12.5 mm
- rotatable 360°, fixable setting
- weight: 0,65 kg
- protection rating: IP20
- protection class I
- 5 years Hoffmeister warranty
- Made in Germany
- certificates: manufactured according to DIN VDE 0711 / EN 60598, CE
- colour: white (RAL9016)
- 108 711 03 910 S

- Overview of accessories on the following page / s

108 711 03 910 S  
**accessory****Optional accessories**

| description accessory general   | dimensions in mm | item number    | pic.-No. |
|---|------------------|----------------|----------|
| housing for concrete cast<br>for recessed downlights complx.100 INSIDER | ØxH: 342 x 160   | 108 608 10 000 | 01       |
| housing for concrete cast<br>for recessed downlights complx.100 INSIDER | ØxH: 342 x 170   | 108 607 10 000 | 01       |

01