

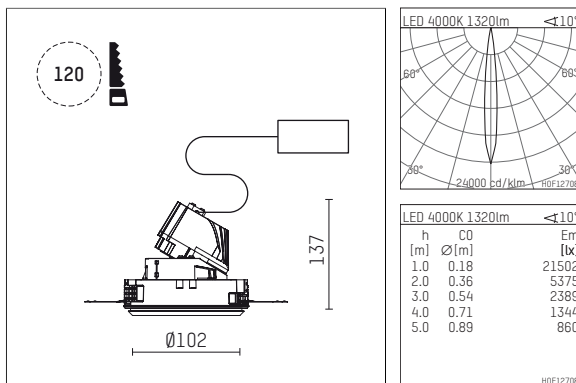

108 731 04 910 SD | white

complx.100 | insider
directional spotlight
LED | 14 W 4000 K



- directional spotlight complx.100 insider
- with ceiling-flush recessing ring
- for plastering into plasterboard ceilings
- with LED 1560 lm
- colour temperature: 4000 K
- colour rendering index: CRI >80
- L90 / B10 (50.000h)
- SDCM < 2
- net luminous flux: 1320 lm
- total load: 14 W
- luminous efficacy: 94,3 lm/W
- rotationsymmetrical light distribution, spot
- safety cable for reflector module
- reflector of aluminium, mirror finish anodised
- beam angle: 10 °
- with external LED power unit, electronic (DALI), 220-240 V, 0/50/60 Hz
- amplitude dimming
- dimming range: 100-1 %
- power supply: supply cord with plug connection 2x5x2,5 mm², length: 360 mm
- housing of die cast aluminium
- safety glass, clear
- recessing ring of die cast aluminium
- height: 127 mm
- diameter: 102 mm, recessing diameter: 120 mm
- recessing depth: 137 mm, ceiling thickness: for 12.5/15/18/20/25 mm
- rotatable 360°, fixable setting, 0°-30° tiltable, fixable setting
- weight: 0,7 kg
- protection rating: IP20
- protection class I
- 5 years Hoffmeister warranty
- Made in Germany
- certificates: manufactured according to DIN VDE 0711 / EN 60598, CE
- colour: white (RAL9016)
- 108 731 04 910 SD

- Overview of accessories on the following page / s

108 731 04 910 SD
accessory**Optional accessories**

description accessory general	dimensions in mm	item number	pic.-No.
housing for concrete cast for recessed downlights complx.100 INSIDER	ØxH: 342 x 160	108 608 10 000	01
housing for concrete cast for recessed downlights complx.100 INSIDER	ØxH: 342 x 170	108 607 10 000	01

01