

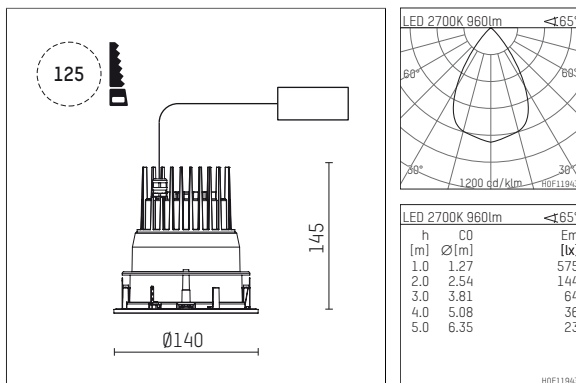

## 109 710 02 910 R | white

complx.100 | IP65  
ceiling recessed luminaire  
LED | 21 W 2700 K



- ceiling recessed luminaire complx.100 IP65
- with a rim projecting over the ceiling
- for installation into suspended ceilings
- with LED 1600 lm
- colour temperature: 2700 K
- colour rendering index: CRI >90
- L90 / B10 (50.000h)
- SDCM < 2
- net luminous flux: 960 lm
- total load: 21 W
- luminous efficacy: 45,7 lm/W
- rotationsymmetrical light distribution, wide flood
- safety cable for reflector module
- darklight reflector of aluminium, mirror finish anodised
- cut of angle: 40 °
- UGR: 17
- with external LED power unit, electronic, 220-240 V, 50/60 Hz
- Dimming with external dimmers possible (trailing-edge and leading-edge)
- dimmable
- power supply: supply cord 2x0,75 mm<sup>2</sup>, length: 200 mm
- housing of die cast aluminium
- safety glass, clear
- recessing ring of die cast aluminium
- height: 135 mm
- diameter: 145 mm, recessing diameter: 125 mm
- recessing depth: 145 mm, ceiling thickness: 2-25mm
- weight: 0,82 kg
- protection rating: IP65 (control gear IP20)
- protection class I
- 5 years Hoffmeister warranty
- Made in Germany
- impact resistance class: IK08
- certificates: manufactured according to DIN VDE 0711 / EN 60598, CE
- colour: white (RAL9016)
- 109 710 02 910 R

- Overview of accessories on the following page / s

109 710 02 910 R  
**accessory****Optional accessories**

description accessory general	dimensions in mm	item number	pic.-No.
IP65 box for LED-Power unit Without power unit (included with DL100 downlight) The recessing depth of the downlight increases(please refer to the mounting instruction for correct values)		119 000 00 721	01
housing for concrete cast for recessed downlights complx.100 IP65	ØxH: 422 x 160	108 606 10 000	02

