

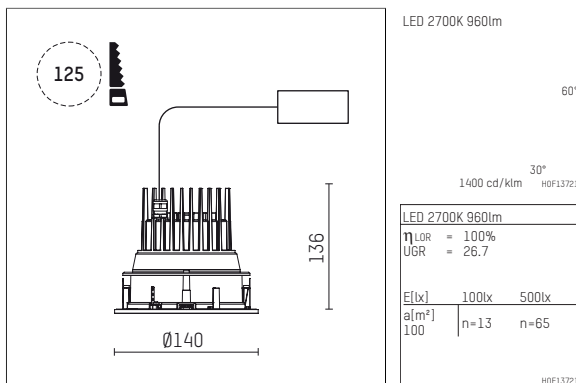

109 711 02 910 R | white

complx.100 | IP65
lens wall floodlight
LED | 21 W 2700 K



- lens wall floodlight complx.100 IP65
- with integrated lens system for homogenous wall illumination
- with a rim projecting over the ceiling
- for installation into suspended ceilings
- with LED 1600 lm
- colour temperature: 2700 K
- colour rendering index: CRI >90
- L90 / B10 (50.000h)
- SDCM < 2
- net luminous flux: 960 lm
- total load: 21 W
- luminous efficacy: 45,7 lm/W
- asymmetrical light distribution
- Sicherheitsfangseil für Reflektorbaugruppe
- darklight reflector of aluminium, mirror finish anodised
- cut of angle: 40 °
- UGR: 27
- with external LED power unit, electronic, 220-240 V, 50/60 Hz
- Dimming with external dimmers possible (trailing-edge and leading-edge)
- dimmable
- power supply: supply cord 2x0,75 mm², length: 200 mm
- housing of die cast aluminium
- safety glass, clear
- recessing ring of die cast aluminium
- height: 126 mm
- diameter: 145 mm, recessing diameter: 125 mm
- recessing depth: 136 mm, ceiling thickness: 2-25mm
- weight: 0,95 kg
- protection rating: IP65 (Vorschaltgerät IP20)
- protection class I
- 5 years Hoffmeister warranty
- Made in Germany
- impact resistance class: IK08
- certificates: manufactured according to DIN VDE 0711 / EN 60598, CE
- colour: white (RAL9016)
- 109 711 02 910 R

- Overview of accessories on the following page / s

109 711 02 910 R
accessory**Optional accessories**

description accessory general	dimensions in mm	item number	pic.-No.
IP65 box for LED-Power unit Without power unit (included with DL100 downlight) The recessing depth of the downlight increases(please refer to the mounting instruction for correct values)		119 000 00 721	01

