

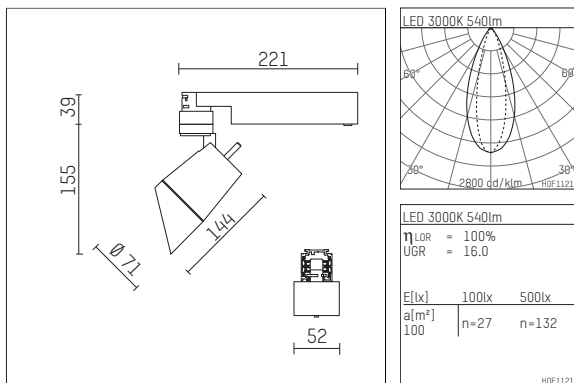

112 125 13 721 | black

gin.o 1
lens wall floodlight
LED | 10 W 3000 K



- lens wall floodlight gin.o 1
- with 3 circuit universal adapter
- for Hoffmeister control.x tracks
- circuit selection is possible while adapter is inserted into the track
- lens wall floodlight for homogenous wall illumination
- passive thermo management
- with LED 800 lm
- colour temperature: 3000 K
- colour rendering index: CRI >90
- L90 / B10 (50.000h)
- SDCM < 2
- net luminous flux: 540 lm
- total load: 10 W
- luminous efficacy: 54,0 lm/W
- asymmetrical light distribution
- soft-lens optic with secondary reflector
- LED power unit integrated in adapter, electronic (POTI), 220-240 V, 0/50/60 Hz
- amplitude dimming
- adapter with integrated potentiometer
- dimming range: 100-0,1 %
- housing of die cast aluminium
- adapter of fibreglass reinforced thermoplastic
- color-, protection- and conversion-filters are available as accessory
- length: 221 mm, width: 52 mm
- rotatable 360°, 90° tiltable
- weight: 1,08 kg
- protection rating: IP20
- protection class I
- 5 years Hoffmeister warranty
- Made in Germany
- maximum ambient temperature: 35 °C
- certificates: manufactured according to DIN VDE 0711 / EN 60598, CE
- colour: black
- 112 125 13 721

- - -