

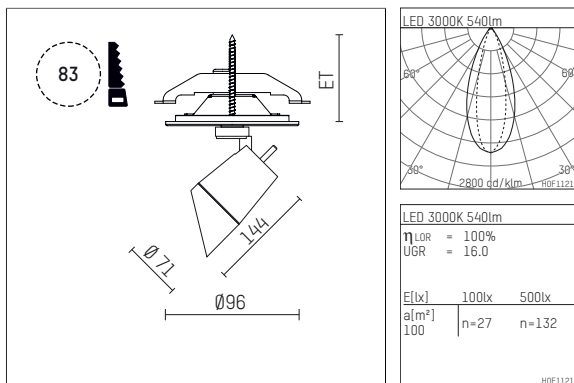

11212513 906-PA | silver

gin.o 1
lens wall floodlight
LED | 10 W 3000 K



- lens wall floodlight gin.o 1
- with recessed mounting plate
- for recessed installation into wall or ceiling
- lens wall floodlight for homogenous wall illumination
- passive thermo management
- with LED 800 lm
- colour temperature: 3000 K
- colour rendering index: CRI >90
- L90 / B10 (50.000h)
- SDCM < 2
- net luminous flux: 540 lm
- total load: 10 W
- luminous efficacy: 54,0 lm/W
- asymmetrical light distribution
- soft-lens optic with secondary reflector
- with external LED power unit, electronic, 220-240 V, 50/60 Hz
- Dimming with external dimmers possible (trailing-edge and leading-edge)
- dimming range: 100-0,1 %
- power supply: supply cord with plug connection 2x5x2,5 mm², length: 360 mm
- suitable for through wiring
- housing of die cast aluminium
- ceiling plate of die cast aluminium
- color-, protection- and conversion-filters are available as accessory
- diameter: 96 mm, recessing diameter: 83 mm
- recessing depth: 63 mm, ceiling thickness: 1-45 mm
- rotatable 360°, 90° tiltable
- weight: 1,2 kg
- protection rating: IP20
- protection class I
- 5 years Hoffmeister warranty
- Made in Germany
- maximum ambient temperature: 35 ° C
- certificates: manufactured according to DIN VDE 0711 / EN 60598, CE
- colour: silver
- 11212513 906-PA

- - -