

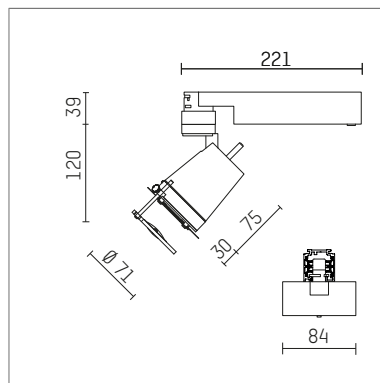

112 140 02 906 D | silver

gin.o 1
Contour spotlight
LED | 10 W 2700 K



- Contour spotlight gin.o 1
- with 3 circuit DALI adapter
- for Hoffmeister control.x tracks
- circuit selection is possible while adapter is inserted into the track
- passive thermo management
- with LED 700 lm
- colour temperature: 2700 K
- colour rendering index: CRI >90
- L90 / B10 (50.000h)
- SDCM < 2
- total load: 10 W
- Contour spotlights
- fresnel lense, glass-lens focusable
- LED power unit integrated in adapter, electronic (DALI), 220-240 V, 0/50/60 Hz
- amplitude dimming
- dimming range: 100-1 %
- housing of die cast aluminium
- adapter of fibreglass reinforced thermoplastic
- framing attachment with holder metal, black
- length: 221 mm, width: 84 mm
- rotatable 360°, 90° tiltable
- weight: 1,23 kg
- protection rating: IP20
- protection class I
- 5 years Hoffmeister warranty
- Made in Germany
- maximum ambient temperature: 35 ° C
- certificates: manufactured according to DIN VDE 0711 / EN 60598, CE
- colour: silver
- 112 140 02 906 D

- - -