

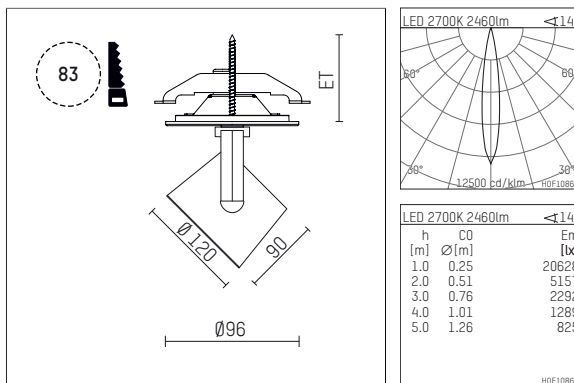

11334212 910-PA | white

lo.nely 3
spotlight
LED | 41 W 2700 K



- spotlight lo.nely 3
- with recessed mounting plate
- for recessed installation into wall or ceiling
- passive thermo management
- with LED 2900 lm
- colour temperature: 2700 K
- colour rendering index: CRI >90
- L90 / B10 (50.000h)
- SDCM < 2
- net luminous flux: 2460 lm
- total load: 41 W
- luminous efficacy: 60,0 lm/W
- rotationsymmetrical light distribution, spot
- beam angle: 15°
- with external LED power unit, electronic
- temperature-controlled LED circuit board (NTC)
- power supply: supply cord with plug connection
2x5x2,5 mm², length: 360 mm
- suitable for through wiring
- housing of die cast aluminium
- microprismatic filter with very high rate of light transmission
- ceiling plate of die cast aluminium
- diameter: 96 mm, recessing diameter: 83 mm
- recessing depth: 103 mm, ceiling thickness: 1-45 mm
- rotatable 360° , 90° tiltable (can be fixed)
- weight: 1,4 kg
- protection rating: IP20
- protection class I
- 5 years Hoffmeister warranty
- Made in Germany
- maximum ambient temperature: 35°C
- certificates: manufactured according to DIN VDE 0711 / EN 60598, CE
- colour: white (RAL9016)
- 11334212 910-PA

- - -

11334212 910-PA
accessory

Required accessories

description accessory general	dimensions in mm	item number	pic.-No.
antiglare flaps for spotlights gin.o and lo.nely size 3		105757	01

