

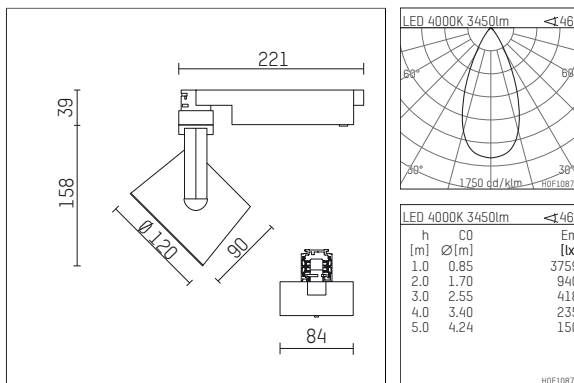

113 344 04 721 D | black

lo.nely 3
spotlight
LED | 41 W 4000 K



- spotlight lo.nely 3
- with 3 circuit DALI adapter
- for Hoffmeister control.x tracks
- circuit selection is possible while adapter is inserted into the track
- passive thermo management
- with LED 4300 lm
- colour temperature: 4000 K
- colour rendering index: CRI >80
- L90 / B10 (50.000h)
- SDCM < 2
- net luminous flux: 3450 lm
- total load: 41 W
- luminous efficacy: 84,2 lm/W
- rotationsymmetrical light distribution, flood
- beam angle: 45 °
- LED power unit integrated in adapter, electronic (DALI)
- temperature-controlled LED circuit board (NTC)
- amplitude dimming
- dimming range: 100-1 %
- housing of die cast aluminium
- adapter of fibreglass reinforced thermoplastic
- microprismatic filter with very high rate of light transmission
- length: 221 mm, width: 84 mm, height: 197 mm
- rotatable 360°, 90° tiltable (can be fixed)
- weight: 1,25 kg
- protection rating: IP20
- protection class I
- 5 years Hoffmeister warranty
- Made in Germany
- maximum ambient temperature: 35 ° C
- certificates: manufactured according to DIN VDE 0711 / EN 60598, CE
- colour: black
- 113 344 04 721 D

- - -

113 344 04 721 D
accessory

Required accessories

description accessory general	dimensions in mm	item number	pic.-No.
antiglare flaps for spotlights gin.o and lo.nely size 3		105757	01

