

## 114 505 03 910 D | white

in.line 2.0 | DALI  
floodlight  
LED | 23 W 3000 K

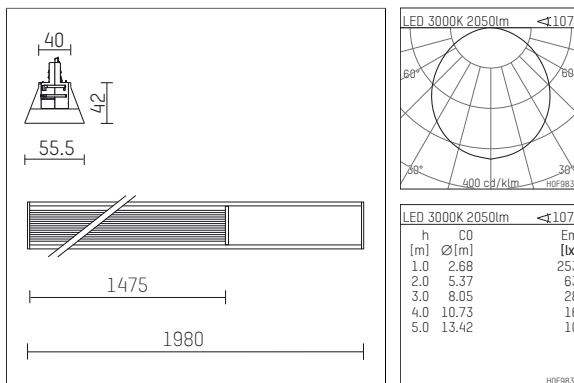

- floodlight in.line 2.0 DALI
- with 3 circuit DALI adapter
- adapter integrated into luminaire profile, operational on the face
- mounting on the track without tools
- with LED 3350 lm
- colour temperature: 3000 K
- colour rendering index: CRI >90
- L70 / B50 (50.000h)
- SDCM < 3
- net luminous flux: 2050 lm
- total load: 23 W
- luminous efficacy: 89,1 lm/W
- symmetrical light distribution, wide flood
- reflector of aluminium, white
- beam angle: 107 °
- UGR: 24
- with built in LED power unit, electronic (DALI)
- amplitude dimming
- dimming range: 100-1 %
- housing of aluminium
- adapter of fibreglass reinforced thermoplastic
- prismatic cover of extrudes polycarbonate, translucent
- length: 1980 mm, width: 55,3 mm, height: 42 mm
- weight: 3,1 kg
- protection rating: IP20
- protection class I
- 5 years Hoffmeister warranty
- Made in Germany
- certificates: manufactured according to DIN VDE 0711 / EN 60598, CE
- colour: white (RAL9016)
- 114 505 03 910 D

- - -