

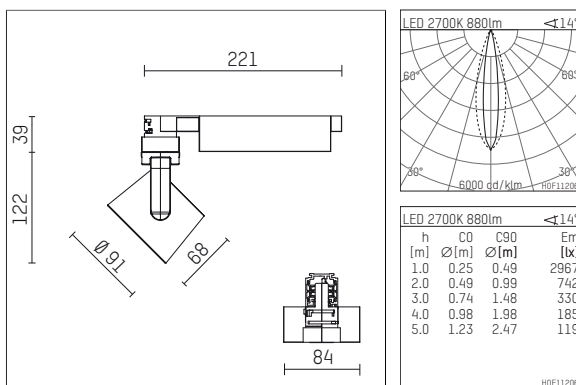

116 526 02 910 D | white

lo.nely 2 | Oval Flood
floodlight
LED | 14 W 2700 K



- floodlight lo.nely 2 Oval Flood
- with 3 circuit DALI adapter
- for Hoffmeister control.x tracks
- circuit selection is possible while adapter is inserted into the track
- with horizontal oval.flood light distribution
- passive thermo.management
- with LED 1060 lm
- colour temperature: 2700 K
- colour rendering index: CRI >90
- L90 / B10 (50.000h)
- SDCM < 2
- net luminous flux: 880 lm
- total load: 14 W
- luminous efficacy: 62,9 lm/W
- oval flood horizontal
- LED power unit integrated in adapter, electronic (DALI), 220-240 V, 0/50/60 Hz
- amplitude dimming
- dimming range: 100-0,5 %
- housing of die cast aluminium
- adapter of fibreglass reinforced thermoplastic
- microprismatic filter with very high rate of light transmission
- color-, protection- and conversion-filters are available as accessory
- length: 221 mm, width: 84 mm, height: 122 mm
- rotatable 360°, 95° tilttable (can be fixed)
- weight: 1,1 kg
- protection rating: IP20
- protection class I
- 5 years Hoffmeister warranty
- Made in Germany
- maximum ambient temperature: 35 °C
- certificates: manufactured according to DIN VDE 0711 / EN 60598, CE
- colour: white (RAL9016)
- 116 526 02 910 D

- - -