

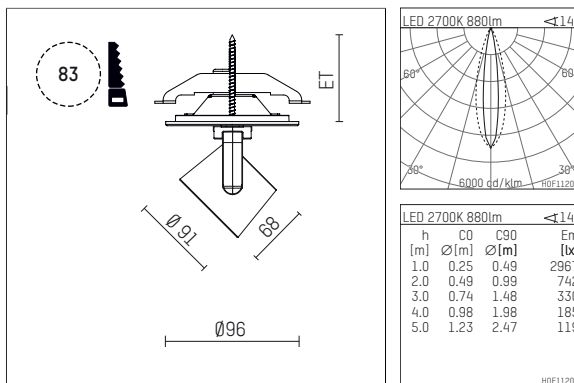

11652612 906-PA | silver

lo.nely 2 | Oval Flood
floodlight
LED | 14 W 2700 K



- floodlight lo.nely 2 Oval Flood
- with recessed mounting plate
- for recessed installation into wall or ceiling
- with horizontal oval flood light distribution
- passive thermo management
- with LED 1060 lm
- colour temperature: 2700 K
- colour rendering index: CRI >90
- L90 / B10 (50.000h)
- SDCM < 2
- net luminous flux: 880 lm
- total load: 14 W
- luminous efficacy: 62,9 lm/W
- oval flood horizontal
- with external LED power unit, electronic, 220-240 V, 50/60 Hz
- Dimming with external dimmers possible (trailing-edge and leading-edge)
- power supply: supply cord with plug connection 2x5x2,5 mm², length: 360 mm
- suitable for through wiring
- housing of die cast aluminium
- microprismatic filter with very high rate of light transmission
- ceiling plate of die cast aluminium
- color-, protection- and conversion-filters are available as accessory
- diameter: 96 mm, recessing diameter: 83 mm
- recessing depth: 63 mm, ceiling thickness: 1-45 mm
- rotatable 360°, 95° tilttable (can be fixed)
- weight: 1,3 kg
- protection rating: IP20
- protection class I
- 5 years Hoffmeister warranty
- Made in Germany
- maximum ambient temperature: 35 ° C
- certificates: manufactured according to DIN VDE 0711 / EN 60598, CE
- colour: silver
- 11652612 906-PA

- - -