

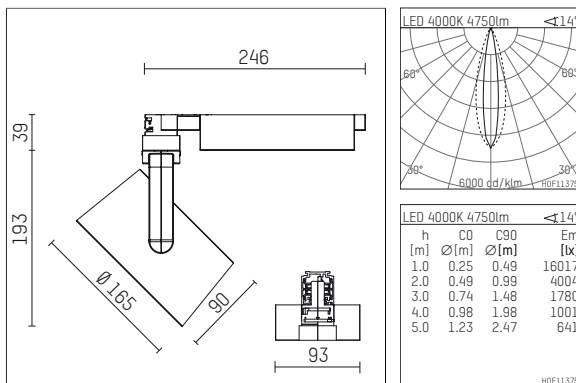

116 546 04 721 D | black

lo.nely 4 | Oval Flood
floodlight
LED | 55 W 4000 K



- floodlight lo.nely 4 Oval Flood
- with 3 circuit DALI adapter
- for Hoffmeister control.x tracks
- circuit selection is possible while adapter is inserted into the track
- with horizontal oval.flood light distribution
- passive thermo management
- with LED 5700 lm
- colour temperature: 4000 K
- colour rendering index: CRI >80
- L90 / B10 (50.000h)
- SDCM < 2
- net luminous flux: 4750 lm
- total load: 55 W
- luminous efficacy: 86,4 lm/W
- oval flood horizontal
- LED power unit integrated in adapter, electronic (DALI), 220-240 V, 0/50/60 Hz
- temperature-controlled LED circuit board (NTC)
- amplitude dimming
- dimming range: 100-1 %
- housing of die cast aluminium
- adapter of fibreglass reinforced thermoplastic
- microprismatic filter with very high rate of light transmission
- *UNDEFINED TEXT*
- length: 246 mm, width: 93 mm, height: 232 mm
- rotatable 360°, 95° tilttable (can be fixed)
- weight: 2,15 kg
- protection rating: IP20
- protection class I
- 5 years Hoffmeister warranty
- Made in Germany
- maximum ambient temperature: 35 °C
- certificates: manufactured according to DIN VDE 0711 / EN 60598, CE
- colour: black
- 116 546 04 721 D

- - -