

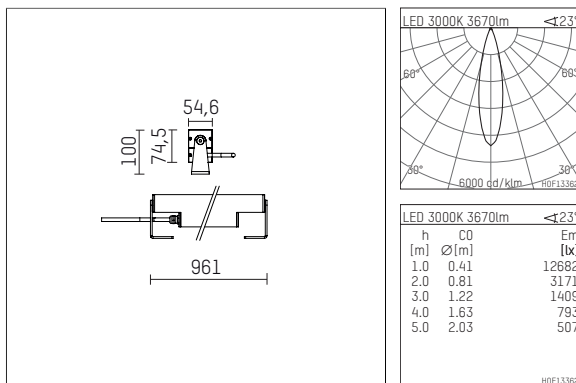

119 624 13 726 | anthracite

led.modular | IP65
linear luminaire
LED | 40 W 3000 K



- linear luminaire led.modular IP65
- adjustable
- with mounting bracket
- for installation on wall or ceiling
- for optimal illumination of vertical facades
- prepared for through wiring
- with LED 4150 lm
- colour temperature: 3000 K
- colour rendering index: CRI >90
- L80 / B10 (50.000h)
- SDCM < 2
- net luminous flux: 3670 lm
- total load: 40 W
- luminous efficacy: 91,8 lm/W
- symmetrical light distribution, medium
- beam angle: 25 °
- with built in LED power unit, electronic, 220-240 V, 0/50/60 Hz
- power supply: supply cord, H05RN-F 3x1 mm², length: 2000 mm
- circular connector RST16 (Wieland)
- housing of extruded aluminium profile
- safety glass, clear
- bracket of stainless steel
- length: 961 mm, width: 54 mm, height: 100 mm
- weight: 5,8 kg
- protection rating: IP65
- protection class I
- 5 years Hoffmeister warranty
- Made in Germany
- maximum ambient temperature: 50 ° C
- impact resistance class: IK07
- certificates: manufactured according to DIN VDE 0711 / EN 60598, CE
- colour: anthracite
- 119 624 13 726

- - -