

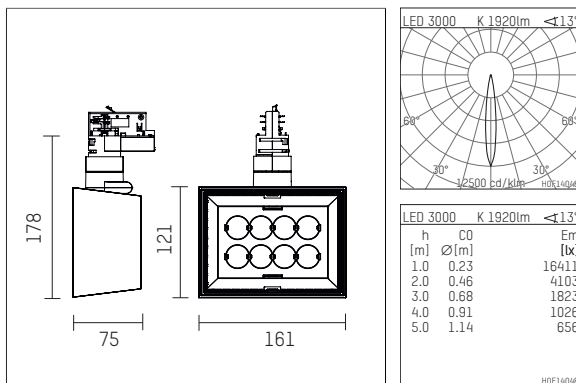

123 223 03 721 | black

li.co
spotlight
LED | 29 W 3000 K



- spotlight li.co
- with 3 circuit universal adapter
- for Hoffmeister control.x tracks
- circuit selection is possible while adapter is inserted into the track
- passive thermo management
- with LED 2200 lm
- colour temperature: 3000 K
- colour rendering index: CRI >90
- L90 / B10 (50.000h)
- SDCM < 2
- net luminous flux: 1920 lm
- total load: 29 W
- luminous efficacy: 66,2 lm/W
- rotationsymmetrical light distribution, spot
- beam angle: 15 °
- with built in LED power unit, electronic, 220-240 V, 0/50/60 Hz
- temperature-controlled LED circuit board (NTC)
- amplitude dimming
- integrated potentiometer
- dimming range: 100-1 %
- housing of die cast aluminium
- adapter of fibreglass reinforced thermoplastic
- length: 75 mm, width: 161 mm, height: 178 mm
- rotatable 360°, 90° tiltable
- weight: 1,08 kg
- protection rating: IP20
- protection class I
- 5 years Hoffmeister warranty
- Made in Germany
- maximum ambient temperature: 35 ° C
- certificates: manufactured according to DIN VDE 0711 / EN 60598, CE
- colour: black
- 123 223 03 721

- Overview of accessories on the following page / s

123 223 03 721
accessory

Optional accessories

description accessory general	dimensions in mm	item number	pic.-No.
cell louver, 8-fold for spotlights li.co		123 142 00 721	01
filter holder suitable for attachment of foils for spotlights li.co		123 130 00 721	01
interchangeable optics, with 8 lenses 10° for spotlights li.co		123 150 00 721	01
interchangeable optics, with 8 lenses 25° for spotlights li.co		123 152 00 721	01
interchangeable optics, with 8 lenses 45°		123 153 00 721	01
interchangeable optics, with wall washer insert for spotlights li.co		123 155 00 721	01
interchangeable optics, with 8 lenses oval flood for spotlights li.co		123 154 00 721	01
accessory frame suitable for attachment of accessories for spotlights li.co	H: 27	123 110 00 721	02
adapter socket, 3-Phasen Ausführung für Deckenaufbaumontage for Hoffmeister spotlights with 3-circuit adapter	ØxH: 101 x 31	110 035 00 721	03
adapter socket, 3-Phasen Ausführung für Deckeneinbaumontage for Hoffmeister spotlights with 3-circuit adapter	Ø: 130	110 036 00 721	04
visor for spotlights li.co		123 140 00 721	05

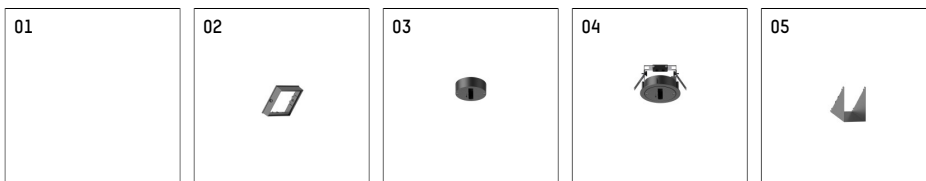

Additional optional accessory components

description accessory general	dimensions in mm	item number	pic.-No.
light shaping diffuser foil, flood for spotlights li.co		123 133 00 000	01
light shaping diffuser foil, medium for spotlights li.co		123 132 00 000	01
light shaping diffuser foil, oval flood horizontal for spotlights li.co		123 134 00 000	01
light shaping diffuser foil, oval flood vertically for spotlights li.co		123 135 00 000	01
light shaping diffuser foil, soft for spotlights li.co		123 131 00 000	01
soft.spot lens for spotlights li.co		123 115 00 000	02

123 223 03 721
accessory

Additional optional accessory components

description accessory general	dimensions in mm	item number	pic.-No.
soft.shape lens for spotlights li.co		123 112 00 000	02
wide-flood Prismatic for spotlights li.co		123 113 00 000	02
prismatic horizontal for spotlights li.co		123 111 00 000	02
prismatic vertically for spotlights li.co		123 117 00 000	01
honeycomb louver for Spotlight li.co		123 116 00 721	03

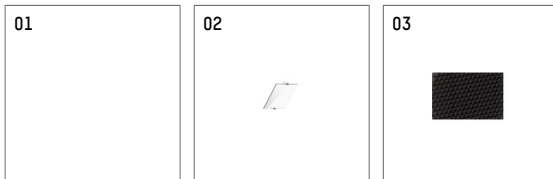

Possible optional accessories combinations

item number	123 111 00 000	123 112 00 000	123 113 00 000	123 115 00 000	123 116 00 721	123 117 00 000	123 131 00 000	123 132 00 000	123 133 00 000	123 134 00 000	123 135 00 000
123 142 00 721											
123 130 00 721						X	X	X	X	X	
123 150 00 721											
123 152 00 721											
123 153 00 721											
123 155 00 721											
123 154 00 721											
123 110 00 721	X	X	X	X	X	X					
110 035 00 721											
110 036 00 721											
123 140 00 721											