

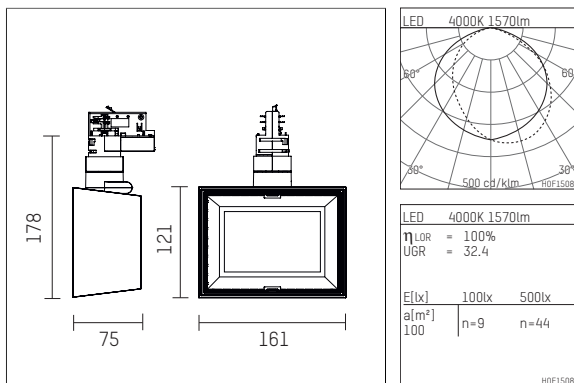

123 227 04 910 D | white

li.co
wallwasher
LED | 29 W 4000 K



- wallwasher li.co
- with 3 circuit universal adapter
- for Hoffmeister control.x tracks
- circuit selection is possible while adapter is inserted into the track
- lens wall floodlight for homogenous wall illumination
- passive thermo management
- with LED 2870 lm
- colour temperature: 4000 K
- colour rendering index: CRI >80
- L90 / B10 (50.000h)
- SDCM < 2
- net luminous flux: 1570 lm
- total load: 29 W
- luminous efficacy: 54,1 lm/W
- asymmetrical light distribution
- soft-lens optic with secondary reflector
- Reflector segments of aluminium, silver anodised
- with built in LED power unit, electronic (DALI), 220-240 V, 0/50/60 Hz
- temperature-controlled LED circuit board (NTC)
- amplitude dimming
- dimming range: 100-1 %
- housing of die cast aluminium
- adapter of fibreglass reinforced thermoplastic
- length: 75 mm, width: 161 mm, height: 178 mm
- rotatable 360°, 90° tiltable
- weight: 1,1 kg
- protection rating: IP20
- protection class I
- 5 years Hoffmeister warranty
- Made in Germany
- maximum ambient temperature: 35 ° C
- certificates: manufactured according to DIN VDE 0711 / EN 60598, CE
- colour: white (RAL9016)
- 123 227 04 910 D

- Overview of accessories on the following page / s

123 227 04 910 D
accessory**Optional accessories**

description accessory general	dimensions in mm	item number	pic.-No.
adapter socket, DALI Ausführung für Deckenaufbaumontage for Hoffmeister spotlights with DALI adapter	ØxH: 101 x 31	110 035 00 910 D	01
adapter socket, DALI Ausführung für Deckeneinbaumontage for Hoffmeister spotlights with DALI adapter	Ø: 130	110 036 00 910 D	02
visor for spotlights li.co		123 140 00 910	03

