



124 603 04 910 | white

DL 100 | IP65

downlight

LED COB | 16 W 4000 K

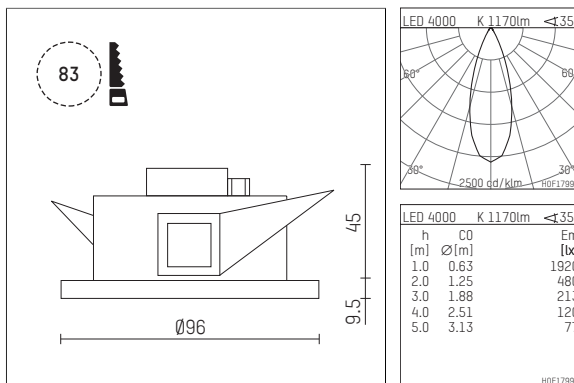

- downlight DL 100 IP65
- with a rim projecting over the ceiling
- for installation into suspended ceilings or casting drums
- with LED COB 1600 lm
- colour temperature: 4000 K
- colour rendering index: CRI >90
- L90 / B10 (50.000h)
- SDCM < 2
- net luminous flux: 1170 lm
- total load: 16 W
- luminous efficacy: 73,1 lm/W
- rotationsymmetrical light distribution, medium
- beam angle: 35 °
- UGR: 20
- with external LED power unit, electronic, 220-240 V, 0/50/60 Hz
- power supply: accessory for through-wiring 2x5x2,5 mm²
- housing of die cast aluminium
- safety glass, clear
- ceiling trim of thermoplastic
- height: 45 mm
- diameter: 96 mm, recessing diameter: 83 mm
- recessing depth: 67 mm, ceiling thickness: max. 25 mm
- weight: 0,64 kg
- protection rating: IP65 (control gear IP20)
- protection class II
- 5 years Hoffmeister warranty
- Made in Germany
- maximum ambient temperature: 40 ° C
- certificates: manufactured according to DIN VDE 0711 / EN 60598, CE
- colour: white
- 124 603 04 910

- Overview of accessories on the following page / s

124 603 04 910
accessory

Optional accessories

description accessory general	dimensions in mm	item number	pic.-No.
IP65 box for LED-Power unit Without power unit (included with DL100 downlight)The recessing depth of the downlight increases(please refer to the mounting instruction for correct values)		107174	01

