

1546080KW08-1D | silver

154
plane projector
LED | 80 W 5700 K

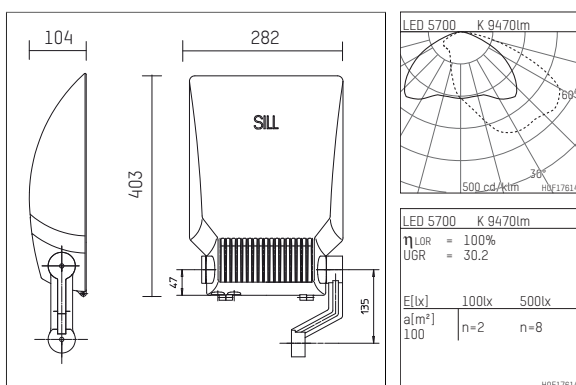

- plane projector 154
- with adjustable mounting arm
- for mounting to column top or wall bracket
- mounting devices must be ordered separately
- with LED 12620 lm
- colour temperature: 5700 K
- colour rendering index: CRI >80
- L90 / B10 (100.000 / ta 25°C)
- SDCM < 3
- net luminous flux: 9470 lm
- total load: 80 W
- luminous efficacy: 118,4 lm/W
- asymmetrical light distribution, wide beam
- with built in LED power unit, electronic (DALI), 220-240 V, 0/50/60 Hz
- including thermal protection for driver and LED module
- optional DC voltage suitable (AC/DC) - 15% power for operation in emergency lighting systems
- further dimming functions on request
- amplitude dimming
- Number of luminaires per fuse (B16): 10
- power supply: 5-pole supply cord 1 mm²
- connection cable 0,6 m concealed in mounting arm
- corrosion resistant aluminium housing AlSi12
- safety glass, clear
- glass can be hinged opened by releasing two captive screws
- with additional safety cable
- length: 403 mm, width: 282 mm, height: 104 mm
- pivot range +120°/-45°
- windage area: 0,04 m²
- weight: 5,9 kg
- protection rating: IP65
- protection class I
- 5 years warranty
- designed and manufactured in Germany
- minimum ambient temperature: -40 °C
- maximum ambient temperature: 35 °C
- impact resistance class: IK08
- certificates: manufactured according to DIN VDE 0711 / EN 60598
- colour: silver (RAL9006)
- 1546080KW08-1D

- Overview of accessories on the following page / s

1546080KW08-1D
accessory

Required accessories

description accessory general	dimensions in mm	item number	pic.-No.
pole attachment, for lateral mounting arm \varnothing 76mm for projector series 151 and 154		845400600	01
pole attachment, for lateral mounting arm \varnothing 60mm for projector series 151 and 154		845400800	01
pole attachment, for lateral mounting arm \varnothing 90mm for projector series 151 and 154		845400400	01
pole attachment, for lateral mounting arm \varnothing 114mm for projector series 151 and 154		845400500	01
Column top, for column diameter 60mm for projector series 151 and 154		845400160D	02
Column top, for column diameter 76mm for projector series 151 and 154		845400176D	02
Wall and ceiling holder for projector series 151 and 154		845400300D	03

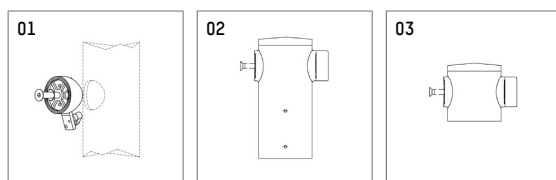

Optional accessories

description accessory general	dimensions in mm	item number	pic.-No.
Screen with louvres, vertical for projector series 153 and 154	LxH: 419 x 272	845301000	01
Screen with louvres, horizontal for projector series 153 and 154	LxH: 419 x 272	845300900	02
Bird deterrent for plane projectors 153/154		845300700	03
protective grid for plane projectors 153/154		845400700	04

