

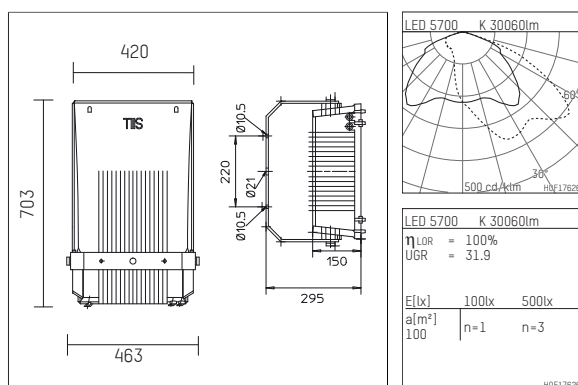

1556240KW12-2D | unpainted

155
plane projector
LED | 240 W 5700 K



- plane projector 155
- with mounting bracket
- for wall-, ground or pole-mounting
- with LED 36220 lm
- colour temperature: 5700 K
- colour rendering index: CRI >80
- L90 / B10 (100.000 / ta 25°C)
- SDCM < 3
- net luminous flux: 30060 lm
- total load: 240 W
- luminous efficacy: 125,3 lm/W
- asymmetrical light distribution, wide beam
- with two integrated power units, electronic (DALI), 220-240 V, 0/50/60 Hz
- including thermal protection for driver and LED module
- optional DC voltage suitable (AC/DC) - 15% power for operation in emergency lighting systems
- further dimming functions on request
- Number of luminaires per fuse (B16): 3
- power supply: connecting terminal 5x2,5 mm²
- loop-in loop-out capable, for cable diameter 8-12mm
- corrosion resistant aluminium housing AlSi12
- safety glass, frosted
- length: 703 mm, width: 420 mm, height: 150 mm
- pivot range +153°/-142°
- windage area: 0,10 m²
- weight: 19 kg
- protection rating: IP65
- protection class I
- 5 years warranty
- designed and manufactured in Germany
- minimum ambient temperature: -40 °C
- maximum ambient temperature: 22 °C
- impact resistance class: IK08
- certificates: manufactured according to DIN VDE 0711 / EN 60598, CE
- colour: unpainted
- 1556240KW12-2D

- Overview of accessories on the following page / s

1556240KW12-2D
accessory

Optional accessories

description accessory general	dimensions in mm	item number	pic.-No.
Column top, for 1 plane projector without mounting bracket and with column diameter 102 mm for plane projectors 155	L: 750	84551000	01
Column top, for 2 plane projectors 90° without mounting bracket and with column diameter 102 mm for plane projectors 155	L: 750	84552090	02
Column top, for 2 plane projectors 180° without mounting bracket and with column diameter 102 mm for plane projectors 155	L: 750	84552180	03
Column top, for 3 plane projectors 90° without mounting bracket and with column diameter 102 mm for plane projectors 155	L: 750	84553090	04
Column top, for 3 plane projectors 120° without mounting bracket and with column diameter 102 mm for plane projectors 155	L: 750	84553120	05
Column top, for 4 plane projectors 90° without mounting bracket and with column diameter 102 mm for plane projectors 155	L: 750	84554090	06
wall bracket, anti-vibration mounting for plane projectors 155		845501400	07
Traverse bracket, anti-vibration mounting for plane projectors 155		845501500	08
Traverse attachment, for one projector with column diameter 102 mm for plane projectors 155	L: 750	84551001	09
Traverse attachment, for two projectors with diameter 102 mm for plane projectors 155	L: 750	84551002	10
Bird deterrent for plane projectors 155		845501600	11
Four-sided screen for plane projectors serie 155		845501000	12

