

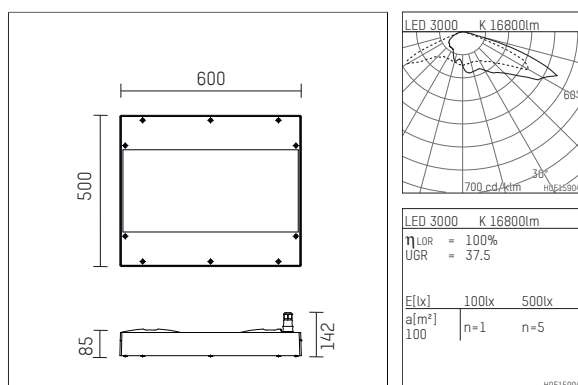

1765150WW70D | silver

176
Industrial luminaire
LED | 150 W 3000 K



- Industrial luminaire 176
- for ceiling mounting and pendant installation
- mounting devices must be ordered separately
- with LED 20280 lm
- colour temperature: 3000 K
- colour rendering index: CRI >70
- L90 / B10 (100.000 / ta 25°C)
- SDCM < 3
- net luminous flux: 16800 lm
- total load: 150 W
- luminous efficacy: 112,0 lm/W
- asymmetrical light distribution
- 2 integrated LED power units, electronic (DALI), 220-240 V, 0/50/60 Hz
- dimmable 10-100%
- Number of luminaires per fuse (B16): 5
- power supply: plug connector 5x2,5 mm²
- Optional loop-in loop-out cabling possible
- housing of die cast aluminium
- safety glass, clear
- with PC cover available on request
- length: 600 mm, width: 500 mm, height: 142 mm
- windage area: 0,30 m²
- weight: 18,6 kg
- protection rating: IP65 (IP66 available on request)
- protection class I
- 5 years warranty
- Designed and manufactured in Germany
- minimum ambient temperature: -40 °C
- maximum ambient temperature: 45 °C
- impact resistance class: IK06
- certificates: manufactured according to DIN VDE 0711 / EN 60598, CE, proof against ball impact
- colour: silver (RAL9006)
- 1765150WW70D

- Overview of accessories on the following page / s

1765150WW70D

accessory**Required accessories**

description accessory general	dimensions in mm	item number	pic.-No.
Ceiling fixation for series 176		817600200	01
Pivoting bracket, for wall and ceiling mounting Ball-proof for series 176		817600300	02
Steelwire suspension, 2xY-FIT, 2x4m for series 176		817600100	03

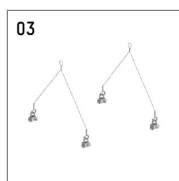
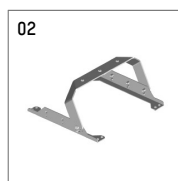
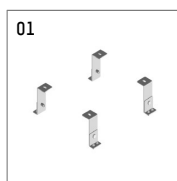
**Optional accessories**

description accessory general	dimensions in mm	item number	pic.-No.
plug connection, RST20i5 for double connection 5-pole, 20 A cable diameter 10-14mm with cross section max. 1,5 mm ²		817600400	01

