

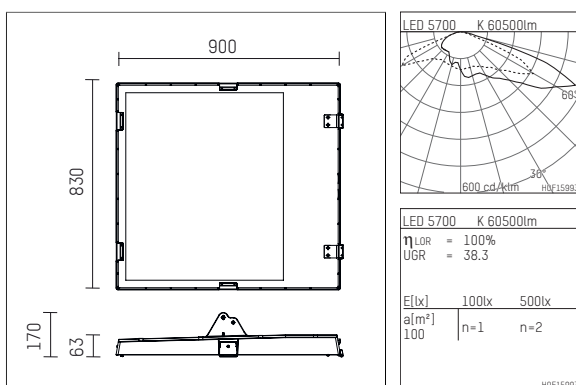

1775450KW70D | unpainted aluminium

177 | 2.0
Arealfooter
LED | 450 W 5700 K

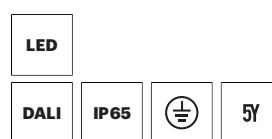

- Arealfooter 177 2.0
- for surface mounted installation on wall or ceiling
- mounting bracket must be ordered separately
- with LED 80200 lm
- colour temperature: 5700 K
- colour rendering index: CRI >70
- L90 / B10 (100.000 / ta 25°C)
- net luminous flux: 60500 lm
- total load: 450 W
- luminous efficacy: 134,4 lm/W
- asymmetrical light distribution
- 3 integrated LED power units, electronic (DALI), 220-240 V, 0/50/60 Hz
- overvoltage protection 10kV; discharge current 5kA
- dimmable 10-100%
- Number of luminaires per fuse (B16): 3
- power supply: plug connector angled 90° RST 20i5 5x2,5 mm²
- Optional loop-in loop-out cabling
- housing of aluminium and die cast aluminium
- safety glas, clear, partially ceramic printed
- length: 900 mm, width: 830 mm, height: 170 mm
- windage area: 0,75 m²
- weight: 37,2 kg
- protection rating: IP65
- protection class I
- 5 years warranty
- designed and manufactured in Germany
- minimum ambient temperature: -40 ° C
- maximum ambient temperature: 55 ° C
- certificates: manufactured according to DIN VDE 0711 / EN 60598
- colour: unpainted aluminium
- 1775450KW70D

- Overview of accessories on the following page / s

1775450KW70D

accessory**Required accessories**

description accessory general	dimensions in mm	item number	pic.-No.
Ceiling fixation for series 177		817700200	01
Mounting bracket, traverse mounting for series 177		817700300	02
Mounting bracket, for wall mounting		817700400	03

