

## 48L2140NWD916 | silver

48L  
plane projector  
LED | 140 W 4000 K

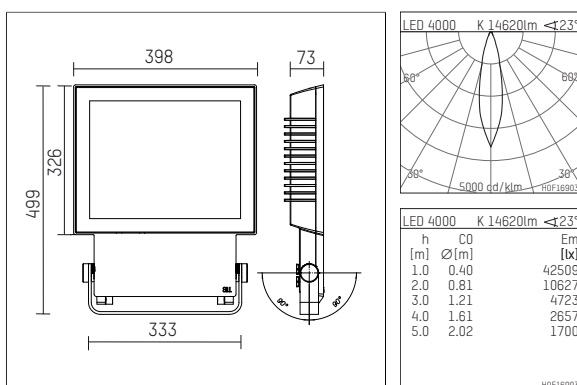
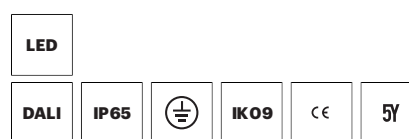

- plane projector 48L
- for wall- or pole-mounting
- with pivoting mounting bracket
- with LED 16810 lm
- colour temperature: 4000 K
- colour rendering index: CRI >80
- L80 / B10 (100.000h)
- SDCM < 3
- net luminous flux: 14620 lm
- total load: 140 W
- luminous efficacy: 104,4 lm/W
- rotationsymmetrical light distribution
- beam angle: 25 °
- with built in LED power unit, electronic (DALI), 220-240 V, 0/50/60 Hz
- including thermal protection for driver and LED module
- overvoltage protection 6KV
- optional DC voltage suitable (AC/DC) - 15% power for operation in emergency lighting systems
- further dimming functions on request
- amplitude dimming
- dimming range: 100-10 %
- Number of luminaires per fuse (B16): 7
- power supply: connecting terminal 5x2,5 mm²
- 2xM20 cable gland for cables 8-12mm, mains loop-in loop-out capable
- corrosion resistant aluminium housing AlSi12
- length: 499 mm, width: 398 mm, height: 73 mm
- ± 90° tiltable
- windage area: 0,18 m²
- weight: 12,4 kg
- protection rating: IP65
- protection class I
- 5 years warranty
- designed and manufactured in Germany
- minimum ambient temperature: -40 ° C
- maximum ambient temperature: 45 ° C
- impact resistance class: IK09
- certificates: manufactured according to DIN VDE 0711 / EN 60598, CE
- colour: silver (RAL9006)
- 48L2140NWD916

- Overview of accessories on the following page / s

48L2140NWD916  
accessory

## Optional accessories

description accessory general	dimensions in mm	item number	pic.-No.
Wire guard for projector 49L and 48 L		849L00100	01
Adjustable screen-doors with opening blades for projector 49L		849L00600	02
Four-sided screen for projector 49L and 48L		849L00200	03
Horizontal screen, with adjustable blades for projector 49L and 48L		849L00300	04
Vertical screen, with adjustable blades for projector 49L and 48L		849L00400	05
Three-sided screen for projector 49L und 48L		849L00500	06
frosted glass, for diffusing for projector 49L and 48L		849L02100	07
Clear glass partially frosted, for diffusing the upper or lower part of light emission for projector 49L and 48L		849L02200	08
Structured glass Albarino S, Fine structure for diffusion, light transmission 91,5% for projector 49L and 48L		849L02600	09
Grooved glass horizontal, type 555 B for projector 49L und 48L		849L02300	10
Grooved glass vertical, type 555 B for projector 49L and 48L		849L02400	11
Conversion filter daylight, Raises the colour temperature from 3000K to 4450K and from 5700K to 14.500K for projector 49L and 48L		849L03200	12
Conversion filter neutral, Raises the colour temperature from 3000K to 3650K for projector 49L and 48L		849L03100	13
Conversion filter warm, Lowers the colour temperature from 3000K to 2600K for projector 49L and 48L		849L03000	14
Mounting bracket, vibration damping for projector 49L and 48L		849L01000	15
Wall outrigger arm, L=0,5m for projector series 49L and 48L		849400500	16
Column outrigger arm, for column diameters 80-120 mm for projector 49L and 48L		849400700	17
Column clamp stainless steel v2a / hot galvanized, for column diameters 115-120 mm		855500 200-120	18
Column clamp stainless steel v2a / hot galvanized, for column diameters 150-170 mm		855500 200-170	18
Column clamp stainless steel v2a / hot galvanized, for column diameters 55-60 mm		855500 200-60	18
Column clamp stainless steel v2a / hot galvanized, for column diameters 60-89 mm		855500 200-89	18
Column clamp stainless steel v2a / hot galvanized, for column diameters 85-92 mm		855500 200-92	18
honeycomb louver for projector 49L and 48L		849L02000	19

48L2140NWD916  
**accessory**

