

48M460NWD916 | silver

48M
plane projector
LED | 60 W 4000 K

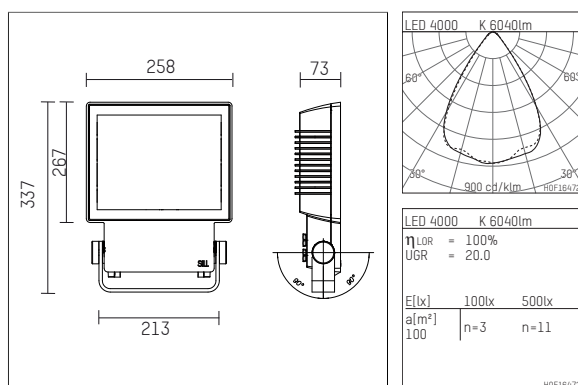

- plane projector 48M
- for wall- or pole-mounting
- with pivoting mounting bracket
- with LED 8400 lm
- colour temperature: 4000 K
- colour rendering index: CRI >80
- L80 / B10 (100.000h)
- SDCM < 3
- net luminous flux: 6040 lm
- total load: 60 W
- luminous efficacy: 100,7 lm/W
- rotationsymmetrical light distribution
- beam angle: 65 °
- with built in LED power unit, electronic (DALI), 220-240 V, 0/50/60 Hz
- including thermal protection for driver and LED module
- overvoltage protection 6KV
- optional DC voltage suitable (AC/DC) - 15% power for operation in emergency lighting systems
- further dimming functions on request
- amplitude dimming
- dimming range: 100-10 %
- Number of luminaires per fuse (B16): 10
- power supply: connecting terminal 5x2,5 mm²
- 2xM20 cable gland for cables 8-12mm, mains loop-in loop-out capable
- corrosion resistant aluminium housing AlSi12
- safety glass, clear
- length: 337 mm, width: 258 mm, height: 73 mm
- ± 90° tiltable
- windage area: 0,08 m²
- weight: 5,2 kg
- protection rating: IP65
- protection class I
- 5 years warranty
- designed and manufactured in Germany
- minimum ambient temperature: -40 ° C
- maximum ambient temperature: 55 ° C
- impact resistance class: IK08
- certificates: manufactured according to DIN VDE 0711 / EN 60598
- colour: silver (RAL9006)
- 48M460NWD916

- Overview of accessories on the following page / s

48M460NWD916
accessory

Optional accessories

description accessory general	dimensions in mm	item number	pic.-No.
Wire guard for projector 49M and 48M		849M00100	01
Four-sided screen for projector 49M and 48M		849M00200	02
Horizontal screen, with adjustable blades for projector 49M and 48M		849M00300	03
Vertical screen, with adjustable blades for projector 49M		849M00400	04
Three-sided screen for projector 49M and 48M		849M00500	05
Screen-doors with 12 opening blades for projector 49M and 48M		849M00700	06
Screen doors with 4 opening blades for projector 49M and 48M		849M00600	07
frosted glass, for diffusing for projector 49M and 48M		849M02100	08
Clear glass partially frosted, for diffusing the upper or lower part of light emission for projector 49M and 48M		849M02200	09
Structured glass Albarino S, Fine structure for diffusion, light transmission 91,5% for projector 49M and 48M		849M02600	10
Conversion filter neutral, Raises the colour temperature from 3000K to 3650K for projector 49M and 48M		849M03100	11
Grooved glass vertical, type 555 B for projector 49M and 48M		849M02400	12
Grooved glass horizontal, type 555 B for projector 49M und 48M		849M02300	13
Conversion filter warm, Lowers the colour temperature from 3000K to 2600K for projector 49M and 48M		849M03000	14
Conversion filter daylight, Raises the colour temperature from 3000K to 4450K and from 5700K to 14.500K for projector 49M and 48M		849M03200	15
Mounting bracket, vibration damping for projector 49M and 48M		849M01000	16
Wall outrigger arm, L=0,5m for projector 49S/49M and 48S/48M		849000500	17
Column mounting bracket black, for column diameters 80-120 mm for projector 49S/49M and 48S/48M		849000700	18
Column clamp stainless steel v2a / hot galvanized, for column diameters 115-120 mm		855500 200-120	19
Column clamp stainless steel v2a / hot galvanized, for column diameters 150-170 mm		855500 200-170	19
Column clamp stainless steel v2a / hot galvanized, for column diameters 55-60 mm		855500 200-60	19
Column clamp stainless steel v2a / hot galvanized, for column diameters 60-89 mm		855500 200-89	19
Column clamp stainless steel v2a / hot galvanized, for column diameters 85-92 mm		855500 200-92	19

48M460NWD916

accessory

Optional accessories

description accessory general	dimensions in mm	item number	pic.-No.
Ground Spike, L=300mm for projector series 49S/M and 48S/M		849000900	20
honeycomb louver for projector 49M and 48M		849M02000	21

