

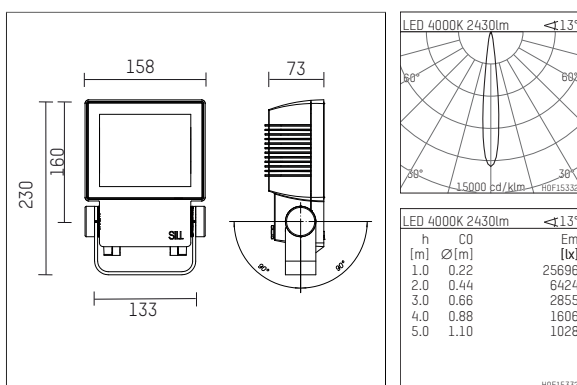

48S130NWD916 | silver

48S
plane projector
LED | 28 W 4000 K



- plane projector 48S
- for wall- or pole-mounting
- with pivoting mounting bracket
- with LED 3450 lm
- colour temperature: 4000 K
- colour rendering index: CRI >80
- L80 / B10 (100.000h)
- SDCM < 3
- net luminous flux: 2430 lm
- total load: 28 W
- luminous efficacy: 86,8 lm/W
- rotationsymmetrical light distribution
- beam angle: 10 °
- with built in LED power unit, electronic (DALI), 220-240 V, 0/50/60 Hz
- amplitude dimming
- dimming range: 100-1 %
- Number of luminaires per fuse (B16): 50
- power supply: connecting terminal 5x2,5 mm²
- M16 cable gland for cables 6-8mm
- corrosion resistant aluminium housing AISi12
- safety glass, clear
- length: 230 mm, width: 158 mm, height: 73 mm
- ± 90° tiltable
- windage area: 0,03 m²
- weight: 2,5 kg
- protection rating: IP65
- protection class I
- 5 years warranty
- designed and manufactured in Germany
- minimum ambient temperature: -25 ° C
- maximum ambient temperature: 50 ° C
- impact resistance class: IK09
- certificates: manufactured according to DIN VDE 0711 / EN 60598
- colour: silver (RAL9006)
- 48S130NWD916

- Overview of accessories on the following page / s

48S130NWD916 accessory

Optional accessories

description accessory general	dimensions in mm	item number	pic.-No.
Four-sided screen for projector 49S and 48S		849S00200	01
Horizontal screen, with adjustable blades for projector 49S and 48S		849S00300	02
Vertical screen, with adjustable blades for projector 49S and 48S		849S00400	03
Three-sided screen for projector 49S and 48S		849S00500	04
frosted glass, for diffusing for projector 49S and 48S		849S02100	05
Clear glass partially frosted, for diffusing the upper or lower part of light emission for projector 49S and 48S		849S02200	06
Structured glass Albarino S, Fine structure for diffusion, light transmission 91,5% for projector 49S and 48S		849S02600	07
Conversion filter neutral, Raises the colour temperature from 3000K to 3650K for projector 49S and 48S		849S03100	08
Conversion filter warm, Lowers the colour temperature from 3000K to 2600K for projector 49S and 48S		849S03000	09
Column mounting bracket black, for column diameters 80-120 mm for projector 49S/49M and 48S/48M		849000700	10
Wall outrigger arm, L=0,5m for projector 49S/49M and 48S/48M		849000500	11
Mounting bracket, vibration damping for projector 49S and 48S		849S01000	12
Column clamp stainless steel v2a / hot galvanized, for column diameters 115-120 mm		855500 200-120	13
Column clamp stainless steel v2a / hot galvanized, for column diameters 150-170 mm		855500 200-170	13
Column clamp stainless steel v2a / hot galvanized, for column diameters 55-60 mm		855500 200-60	13
Column clamp stainless steel v2a / hot galvanized, for column diameters 60-89 mm		855500 200-89	13
Column clamp stainless steel v2a / hot galvanized, for column diameters 85-92 mm		855500 200-92	13
Ground Spike, L=300mm for projector series 49S/M and 48S/M		849000900	14
Grooved glass horizontal, type 555 B for projector 49S and 48S		849S02300	15
Grooved glass vertical, type 555 B for projector 49S und 48S		849S02400	16



48S130NWD916
accessory

